

# **Display Color Analyzer CA-210**

**INSTRUCTION MANUAL**



**KONICA MINOLTA**

# Safety Symbols

---

The following symbols are used in this manual to prevent accidents which may occur as result of incorrect use of the instrument.



Denotes a sentence regarding safety warning or note.  
Read the sentence carefully to ensure safe and correct use.



Denotes a sentence regarding safety precautions for risk of fire.  
Read the sentence carefully to ensure safe and correct use.



Denotes a sentence regarding safety precautions for risk of electric shock.  
Read the sentence carefully to ensure safe and correct use.



Denotes a prohibited operation.  
The operation must never be performed.



Denotes an instruction.  
The instruction must be strictly adhered to.



Denotes an instruction.  
Disconnect the AC power cord from the AC outlet.



Denotes a prohibited operation.  
The part must never be disassembled.



Denotes an instruction.  
Connect the grounding terminal as instructed.

## SIP/SOP Connections

---



























- Accessories equipment connected the analog and digital interfaces must be certified to the respective IEC standards (i.e. IEC 60950 for data processing equipment).
- Furthermore all configurations shall comply with the system standard IEC 61010-1. Everybody who connects additional equipment to the signal input part or signal output part configures a electrical equipment for measurement system, and is therefore, responsible that the system complies with the requirements of the system standard (IEC 61010-1. If in doubt, consult the technical services department or your local representative).





### Notes on this Manual

- Copying or reproduction of all or any part of the contents of this manual without KONICA MINOLTA's permission is strictly prohibited.
- The contents of this manual are subject to change without prior notice.
- Every effort has been made in the preparation of this manual to ensure the accuracy of its contents. However, should you have any questions or find any errors, please contact a Konica Minolta authorized service facility.
- KONICA MINOLTA will not accept any responsibility for consequences arising from the use of the instrument.

# Safety Precautions

When using this hardware, the following points must be strictly observed to ensure correct and safe use. After you have read this manual, keep it in a safe place so that it can be referred to easily whenever it is needed.

 <b>WARNING</b> (Failure to adhere to the following points may result in death or serious injury.)	
  <p>Do not use the CA-Series in places where flammable or combustible gases (gasoline etc.) are present. Doing so may cause a fire.</p>	  <p>When disconnecting the AC power cord's plug, always hold the plug and pull it to remove it. Never pull the AC power cord itself. Doing so may damage the AC power cord, causing a fire or electric shock. In addition, do not insert or disconnect the AC power cord's plug with wet hands. Doing so may cause electric shock.</p>
   <p>Always use the AC power cord supplied as a standard accessory (for 100-120V~ or for 200-240V~) with the CA-Series, and connect it to an AC outlet. Failure to do so may damage the CA-Series, causing a fire or electric shock.</p>	   <p>Do not disassemble or modify the CA-Series. Doing so may cause a fire or electric shock.</p>
   <p>Do not bend, twist or pull the AC power cord excessively. In addition, do not place heavy items on the AC power cord, or damage or modify it in any way. Doing so may cause damage to the AC power cord, resulting in fire or electric shock.</p>	    <p>Take special care not to allow liquid or metal objects to enter the CA-Series. Doing so may cause a fire or electric shock. Should liquid or metal objects enter the CA-Series, turn the power OFF immediately, disconnect the AC power cord from the AC outlet, and contact the nearest Konica Minolta authorized service facility.</p>
  <p>If the CA-Series will not be used for a long time, disconnect the AC power cord from the AC outlet. Accumulated dirt or water on the prongs of the AC power cord's plug may cause a fire. If there is any dirt or water on the prongs of the AC power cord's plug, remove it.</p>	   <p>The CA-Series should not be operated if it is damaged, or smoke or odd smells are detected. Doing so may result in a fire. In such situations, turn the power OFF immediately, disconnect the AC power cord from the AC outlet, and contact the nearest Konica Minolta authorized service facility.</p>
  <p>The CA-Series should not be operated if dirt or dust has entered through the vent holes. Doing so may result in a fire. For periodic inspection, contact the nearest Konica Minolta authorized service facility.</p>	 <p>Take care not to drop or overturn the CA-Series. Failure to adhere to this precaution may result in injury or your body being trapped.</p>

 <b>CAUTION</b> (Failure to adhere to the following points may result in injury or damage to the instrument or other property.)	
 <p>Do not place the instrument on an unstable or sloping surface. Doing so may result in its dropping or overturning, causing injury. Take care not to drop the instrument when carrying it.</p>	   <p>Be sure to connect the AC power cord's plug to an AC outlet that has a protective grounding terminal. Also make sure that peripheral devices (e.g. PC) are connected to AC outlets that have a protective grounding terminal. Failure to do so may result in electric shocks.</p>

# Foreword

---

Thank you for purchasing the Display Color Analyzer CA-210. This instrument is designed for measurement of color, and luminance of various types of color displays with Universal Measuring Probe or color, luminance and flicker of color LCD displays with LCD Flicker Measuring Probe. Before using this instrument, please read this manual thoroughly.

## Notes on Use

---

- This instrument is designed for indoor use only, and should not be used outside.
- The instrument must never be disassembled as it is composed of precision electric components.
- Always use the rated power voltage. Connect the AC power cord (for 100-120 V or for 200-240 V) to an AC outlet. Make sure that main supply voltage fluctuates up to  $\pm 10\%$  of the nominal voltage.
- This instrument is classified as Pollution Degree 2 (equipment which may cause temporary electrical hazards due to contamination or condensation, or products which are used in such an environment).
- This instrument is classified as Installation Category II (the specified commercial power voltage should be used).
- Do not use the instrument at altitudes of higher than 2000 m.
- The instrument must not be used if foreign matter such as water and metal objects enter it, doing so is very dangerous.
- The instrument should not be used in certain environments, such as near a heater which will cause an excessive rise in its temperature resulting in breakdown. Therefore it should not be used in such an environment. It should be used in well-ventilated areas, and care should be taken not to allow the vent holes to become blocked.
- The instrument must not be used in areas subject to rapid changes of temperature, to avoid condensation.
- The instrument must not be used in areas where there is an excessive amount of dust or where the humidity is excessively high.
- The instrument should be used at ambient temperatures of between 10 and 28°C and humidity of 70 % relative humidity or less. Be aware that to use it beyond this condition may make it degrade the performance.
- The instrument must not be exposed to excessive impact and vibrations.
- The AC power cord must not be pulled or bent excessively nor must excessive force be exerted on it. Doing so may result in wire breakage.
- The AC power cord must not be connected to an AC line on which excessive noise is present.
- The instrument and personal computer must be grounded.
- If any irregularity or abnormality is found, turn OFF the power immediately, disconnect the AC power cord, and refer to “Troubleshooting Guide” on page 107.
- Should the instrument break down, do not try to disassemble by yourself. Contact a Konica Minolta authorized service facility.
- Zero Calibration shall be made only after duration of 30 minutes or more passed since the power supply switch is turned ON if the luminance of the display to be measured is the following.
  - 1.0 cd/m<sup>2</sup> or less for Universal Measuring Probe (CA-PU12, CA-PU15) / LCD Flicker Measuring Probe (CA-P12, CA-P15)
  - 3.0 cd/m<sup>2</sup> or less for Small Universal Measuring Probe (CA-PSU12, CA-PSU15) / Small LCD Flicker Measuring Probe (CA-PS12, CA-PS15)

## Notes on Storage

---

- The instrument should be stored at temperatures of between 0 and 28°C (70 % relative humidity or less and no condensation) or at temperatures of between 28 and 40°C (40 % relative humidity or less and no condensation). It is recommended that it be stored with a drying agent (such as silica gel) at approximately room temperature. To store it in areas subject to high temperatures and high humidity may make it degrade the performance.
- Take care not to allow condensation to form on the instrument during storage. In addition, pay attention to rapid temperature changes during transportation to the storage area to prevent condensation.

## Cleaning

---

- If the instrument gets dirty, wipe it with a soft dry cloth. Never use solvents (e.g. benzene, thinner) or other chemicals.
- If the optics of the probe gets dirty, wipe it with a soft dry cloth or lens cleaning paper.
- If it is not possible to remove dirt from the instrument, contact a Konica Minolta authorized service facility.

## About This Manual

---

This manual is designed for those who possess basic knowledge of LCD displays.

Before using this instrument, please read this manual thoroughly.

In some parts of the description about Universal Measuring Probe, Small Universal Measuring Probe, LCD Flicker Measuring Probe and Small LCD Flicker Measuring Probe on this manual where type of probe is not specified, they are described as "Measuring Probe".

A quick summary of measurement methods is given in "Measurement/Quick Guide" (pages 114to 118), please refer to it when you need a quick check.

### **For Those Who Want to Purchase Optional Accessories for this Instrument**

This manual also explains how to use optional accessories available for this instrument.

If an explanation of how to use an optional accessory is given in this manual, its product name is also given.

Please read the explanation together with the manual supplied with the accessory.

<Example> ● Location of the explanation regarding 4-Probe Expansion Board

**When the optional 4-Probe Expansion Board CA-B14 is used**

---

# Contents

---

Safety Precautions .....	1
Foreword .....	2
Notes on Use .....	2
Notes on Storage .....	2
Cleaning .....	3
About This Manual .....	3
<b>Manual Structure .....</b>	<b>6</b>
<b>Names and Functions of Parts .....</b>	<b>10</b>
<b>About Accessories .....</b>	<b>13</b>
Standard Accessories .....	13
Optional Accessories .....	13
<b>About Measuring Probe .....</b>	<b>14</b>
Setting a Measuring Probe .....	14
Setting the Measuring Distance .....	14
About Pointing Ring .....	15
<b>Function of Each Key .....</b>	<b>16</b>
<b>About Display .....</b>	<b>19</b>
<b>Installation/Connection .....</b>	<b>23</b>
<b>About Installation .....</b>	<b>25</b>
<b>About Connection .....</b>	<b>26</b>
1. Connecting a Measuring Probe .....	26
2. Installing the 4-Probe Expansion Board CA-B14 <b>When the optional 4-Probe Expansion Board CA-B14 is used</b> .....	27
3. Connecting the Power .....	28
4. Inputting the Vertical Synchronizing Signal .....	28
<b>Turning the Power ON ( I )/OFF ( O ) .....</b>	<b>29</b>
1. Turning the Power ON ( I )/OFF ( O ) .....	29
2. Instrument Status at Power-ON .....	30
3. About the change of Luminance Unit .....	32
<b>Measurement Preparation .....</b>	<b>33</b>
<b>Zero Calibration .....</b>	<b>34</b>
1. Performing Zero Calibration .....	34
2. Zero Calibration Check Method .....	35
<b>Selecting, Measurement Speed, SYNC Mode, Display Mode .....</b>	<b>36</b>
<b>and the Number of Display Digits .....</b>	<b>36</b>
1. Selecting the Measurement Speed .....	36
2. Selecting SYNC Mode .....	38
3. Selecting the Measurement Mode .....	40
4. Selecting the Number of Display Digits .....	42
<b>Selecting Probe No. <b>When the optional 4-Probe Expansion Board CA-B14 is used</b> .....</b>	<b>43</b>
<b>Settings Section .....</b>	<b>45</b>
<b>Outline of the Settings Section .....</b>	<b>46</b>
<b>Before Making Each Setting .....</b>	<b>48</b>
1. About Memory Channels .....	48
2. About the Target Color .....	49
3. Selecting the Calibration Standard (data) .....	50

<b>User Calibration .....</b>	<b>51</b>
1. About User Calibration .....	51
2. Performing White Calibration .....	52
3. Performing Matrix Calibration .....	54
<b>Analyzer Mode .....</b>	<b>58</b>
1. About Analyzer Mode .....	58
2. Inputting the RGB Emission Characteristic for Analyzer Mode .....	59
<b>Setting/Changing the Target Color .....</b>	<b>62</b>
1. Setting/Changing the Target Color by Measurement .....	63
2. Setting/changing the target color by entering values .....	65
<b>Other Settings .....</b>	<b>67</b>
1. Setting an ID Name .....	67
2. Setting the Analog Display Range .....	69
<b>Settings Checking Method .....</b>	<b>73</b>
1. Checking the Set Values .....	73
2. Checking the Probe Serial No. when Making Settings .....	74
<b>Measurement Section .....</b>	<b>75</b>
<b>Measurement .....</b>	<b>76</b>
1. Performing Measurement .....	76
2. Holding the Measured Values .....	77
3. Displaying the Measured Values .....	78
<b>White Balance Adjustment in Analyzer Mode .....</b>	<b>81</b>
<b>Communications Section .....</b>	<b>85</b>
<b>Communicating with PC .....</b>	<b>86</b>
1. Communicating with PC via RS-232C .....	86
2. Selecting the RS-232C Baud Rate .....	87
3. Communicating with PC via USB .....	88
4. Remote Measurement .....	88
<b>Explanation Section .....</b>	<b>89</b>
<b>Measuring Principle .....</b>	<b>90</b>
1. Measuring Principle .....	90
2. About T $\Delta$ uvLv .....	91
3. Principle of User Calibration .....	92
4. Principle of Analyzer Mode .....	93
5. Optical System of CA-210 Probe .....	94
6. Principle of Flicker Mode .....	96
<b>Maintenance .....</b>	<b>101</b>
1. Cleaning the Instrument .....	101
2. Storing the Instrument .....	101
<b>Dimension Diagram .....</b>	<b>102</b>
<b>Error Messages .....</b>	<b>103</b>
<b>Troubleshooting Guide .....</b>	<b>107</b>
<b>Specifications .....</b>	<b>110</b>
<b>Measurement/Quick Guide .....</b>	<b>114</b>

# Manual Structure

This manual is divided into sections as shown below according to the contents.

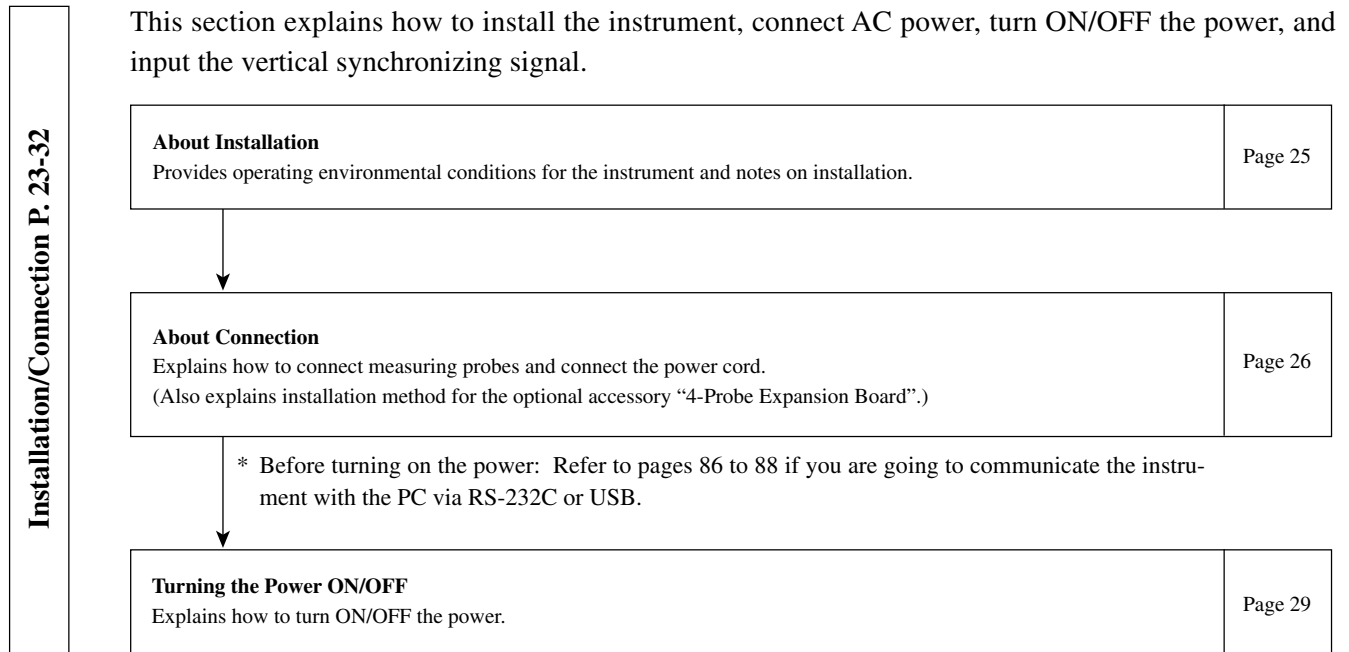

- The Preparation/Setting/Measurement section explains the procedure up to measurement.

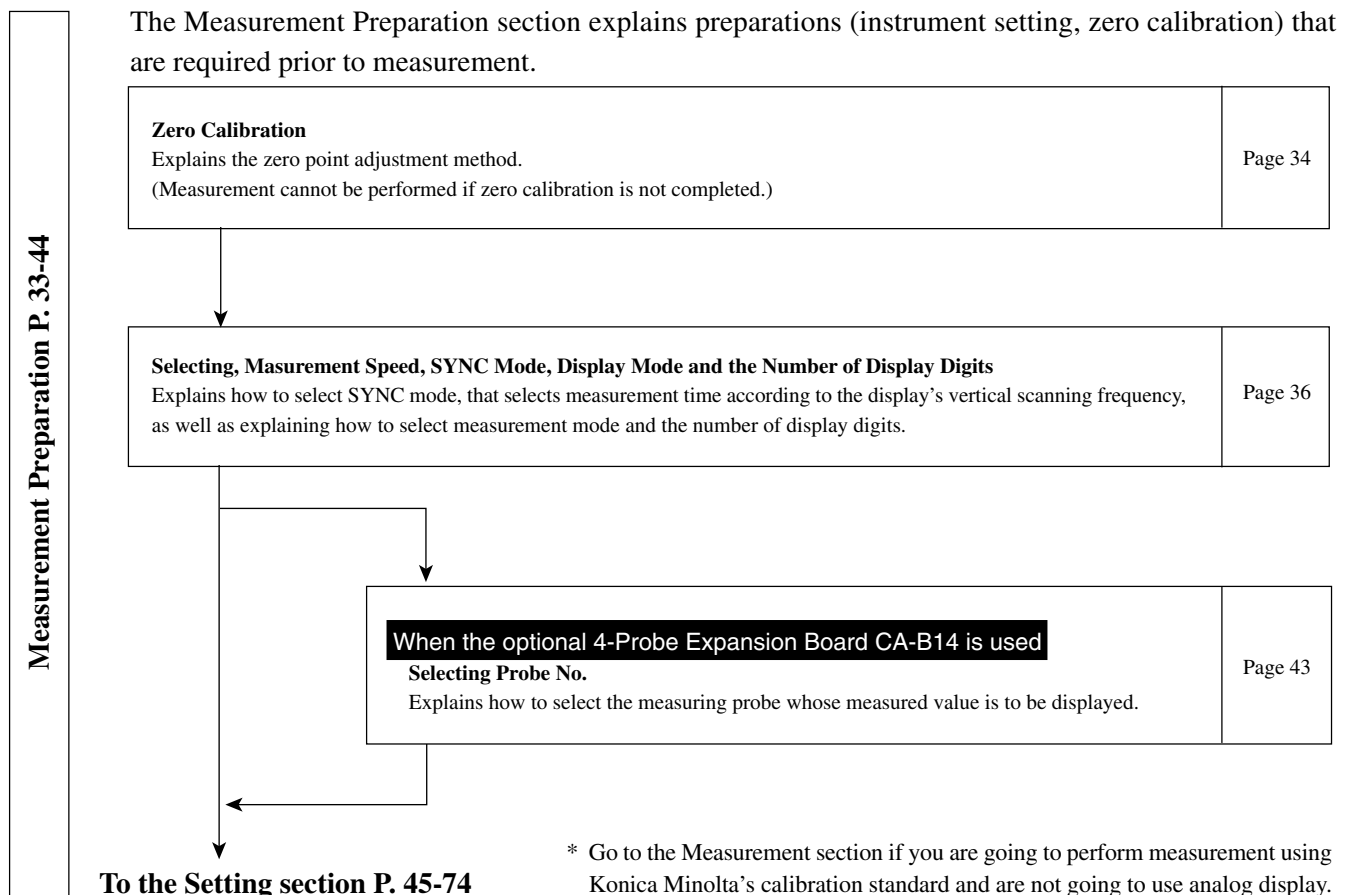



This section explains settings that must be made according to measurement method.  
 The setting method varies with measurement method.

**From the Measurement Preparation section**

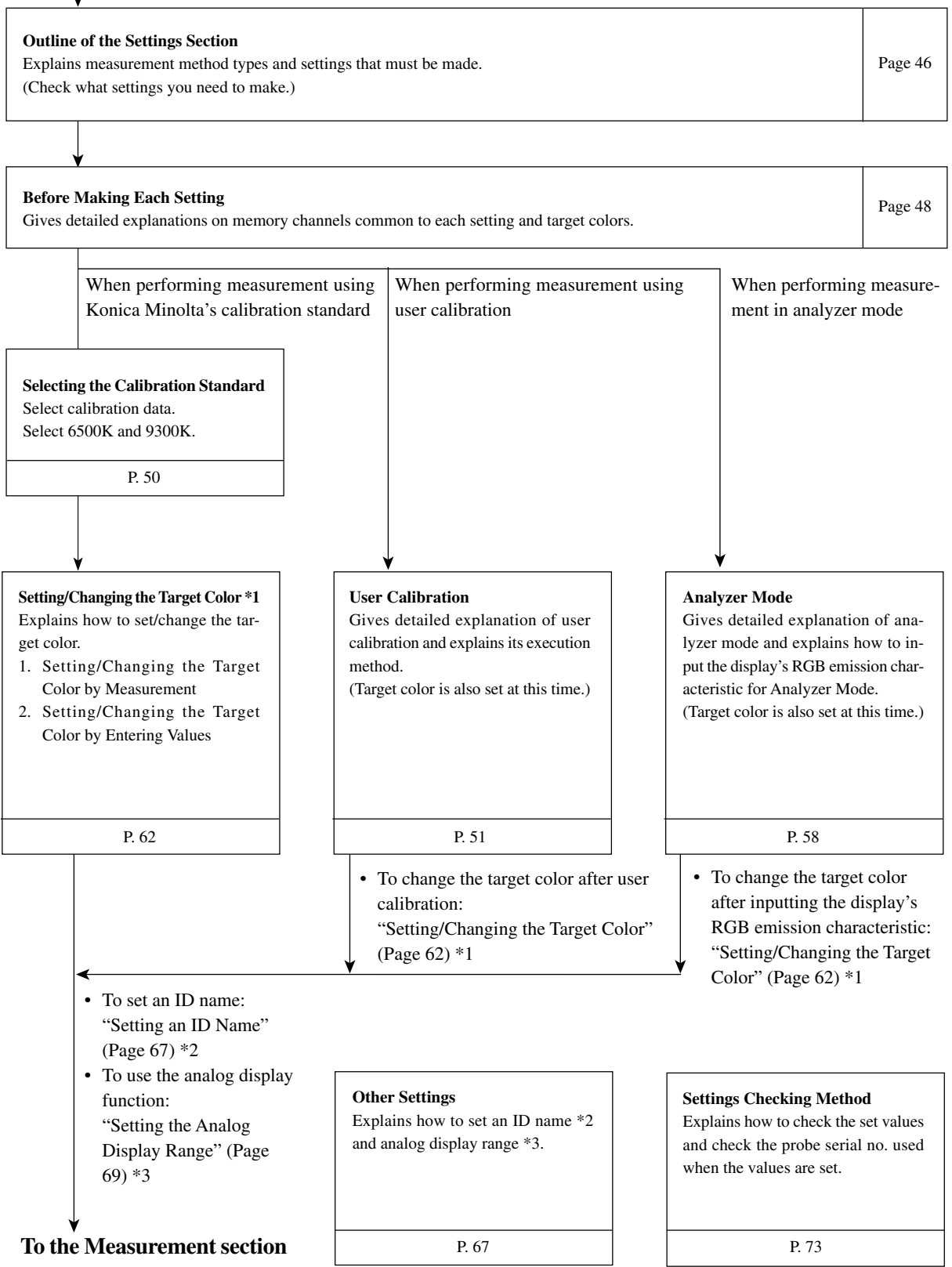

This section explains measuring methods.

**From the Settings section**



<p><b>Measurement</b> Explains measuring methods, how to hold the measured values and how to read them.</p>	<p>Page 76</p>
<p><b>White Balance Adjustment in Analyzer Mode</b> Explains how to adjust white balance.</p>	<p>Page 81</p>

This section explains communication with PC via RS-232C or USB.

<p><b>Communicating with PC via RS-232C</b> Explains how to connect the RS-232C cable and select the RS-232C baud rate to enable two-way communication with PC via RS-232C.</p>	<p>Page 86</p>
<p><b>Communicating with PC via USB</b> Explains how to connect the USB cable to enable communication with PC via USB.</p>	<p>Page 88</p>
<p><b>Remote Measurement</b> Explains how to perform measurement from the PC remotely.</p>	<p>Page 88</p>

This section explains the following items.

<b>Measuring Principle</b>	Page 90
<b>Maintenance</b>	Page 101
<b>Dimension Diagram</b>	Page 102
<b>Error Messages</b> Please read when an error message appears in the LCD display section.	Page 103
<b>Troubleshooting Guide</b> Please read when the instrument does not function correctly.	Page 107
<b>Specifications</b>	Page 110
<b>Measurement/Quick Guide</b> Provides an outline of operations explained in the previous sections (Measurement Preparation - Measurement).	Page 114

# Names and Functions of Parts

## Main Body

### <Front>

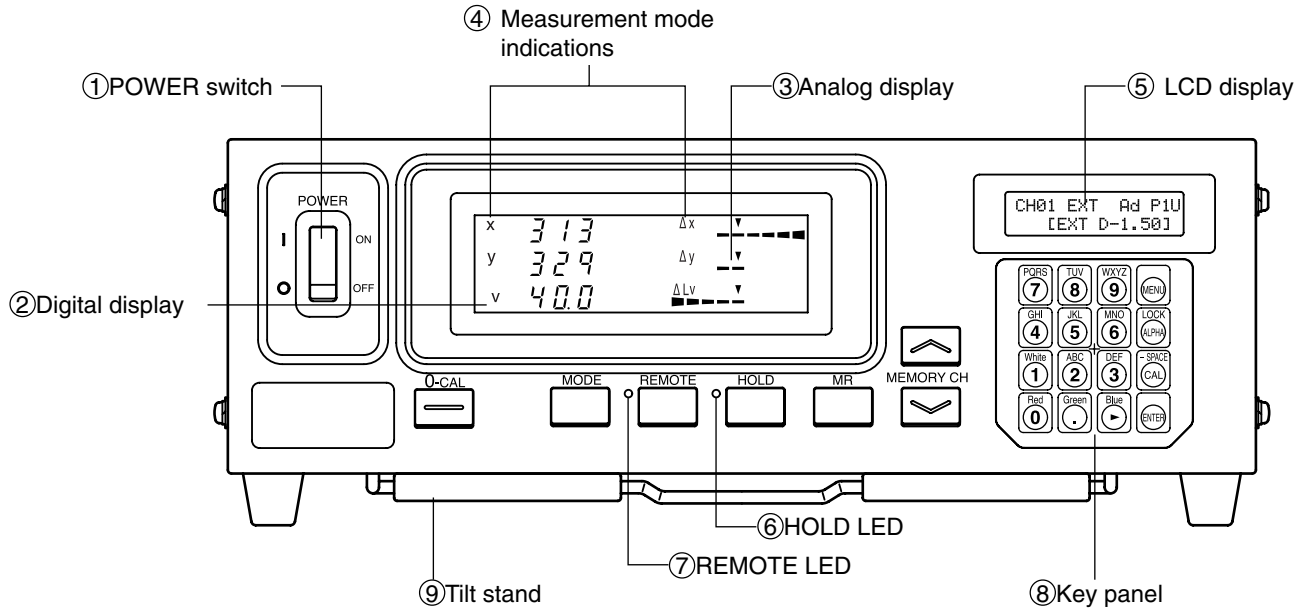

### <Rear>

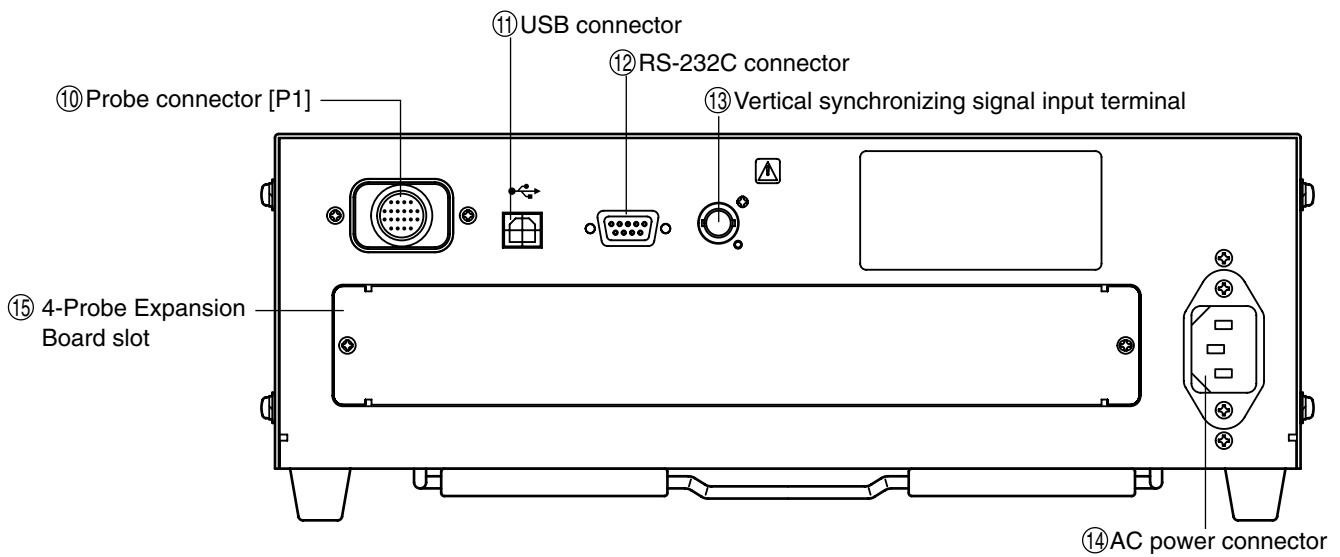

## Main Body

### <Front>

- ① POWER switch ..... • Used to turn ON and OFF the power to the instrument. (Page 29)
- ② Digital display section ..... • Displays the measured values.
- ③ Analog display section ..... • Displays the difference (%) between the measured value and the target color or the difference (%) between measured values. Measured values are displayed in the case of flicker mode.
  - The range for each dot can be set between 0.1 and 99%. (Page 69)
- ④ Measurement mode indications ..... • Displays the measurement mode in which the measured values are displayed. (Page 40)
  - The table below shows the relationship between measurement modes and data displayed in the digital display section 2 and analog display section 3.

Measurement mode	2 Digital display	3 Analog display
xyLv mode	x, y, Lv	$\Delta x$ , $\Delta y$ , $\Delta L_v$
T $\Delta uvLv$ mode	T, $\Delta uv$ , Lv	$\Delta x$ , $\Delta y$ , $\Delta L_v$
Analyzer mode (G reference)	R, B, G	R/G, B/G, $\Delta G$
Analyzer mode (R reference)	R, B, G	$\Delta R$ , B/G, G/R
u'v'Lv mode	u', v', Lv	$\Delta x$ , $\Delta y$ , $\Delta L_v$
Flicker mode**	Flicker value	Flicker value
XYZ mode	XYZ	$\Delta x$ , $\Delta y$ , $\Delta L_v$

\*\*Only when LCD Flicker Measuring Probe or Small LCD Flicker Measuring Probe is connected.

- ⑤ LCD display ..... • Displays the memory channel, probe no., ID name, warning and settings.
- ⑥ HOLD LED ..... • Lights up during hold.
- ⑦ REMOTE LED ..... • Lights up when the instrument is ready for communication with the PC via RS-232C or USB interface.
- ⑧ Key panel ..... • Used to select/set probe no., SYNC mode, measurement speed, analog display range and ID name, as well as entering values. (Page 17)
- ⑨ Tilt stand

### <Rear>

- ⑩ Probe connector [P1] ..... • Used to connect a measuring probe. (Page 26)
- ⑪ USB connector ..... • USB interface for communication with the PC. (Page 88)
- ⑫ RS-232C connector ..... • RS-232C compatible interface for communication with the PC. (Page 86)
- ⑬ Vertical synchronizing signal ..... • Input the display's vertical synchronizing signal into this terminal when performing measurement in EXT SYNC mode. (Page 28)
  - ⚠ SYNC: Terminal shall tread as class 3 accordance with IEC 610101-1 Annex-H.
- ⑭ AC power connector ..... • Connect the AC power cord to this connector to supply power to the instrument. (Page 28)
  - The rating is 100-240V~, 50-60 Hz, 50VA.
- ⑮ 4-Probe Expansion Board slot ..... • Used to install the optional 4-Probe Expansion Board (CA-B14). (Page 27)

**Universal Measuring Probe** CA-PU12(2m) /CA-PU15(5m)  
**Small Universal Measuring Probe** CA-PSU12(2m) /CA-PSU15(5m)  
**LCD Flicker Measuring Probe** CA-P12(2m) /CA-P15(5m)  
**Small LCD Flicker Measuring Probe** CA-PS12(2m) /CA-PS15(5m)

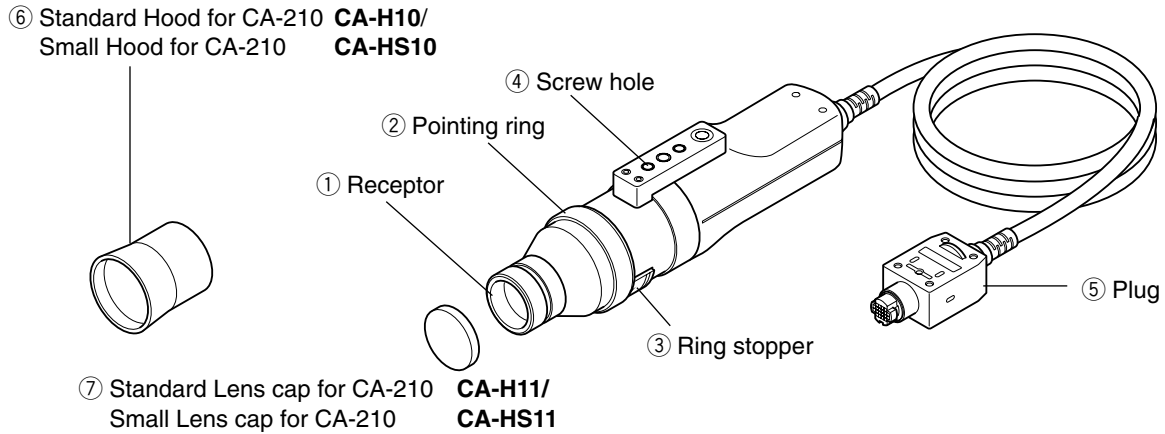

Measuring is done with a probe in intimate contact with the surface of display in the measuring part of this equipment. There are 2 m(6.6ft.) and 5 m(16.4ft) long cord. There are 4 types of Measuring Probe.

Probe model	Cord length	Product name	Probe model	Cord length	Product name
Universal Measuring Probe	2m	CA-PU12	LCD Flicker Measuring Probe	2m	CA-P12
Universal Measuring Probe	5m	CA-PU15	LCD Flicker Measuring Probe	5m	CA-P15
Small Universal Measuring Probe	2m	CA-PSU12	Small LCD Flicker Measuring Probe	2m	CA-PS12
Small Universal Measuring Probe	5m	CA-PSU15	Small LCD Flicker Measuring Probe	5m	CA-PS15

\* Either of the accessories described above is included.

- ① Receptor ..... • Place this receptor against the display’s screen surface and perform measurement.
- ② Pointing ring ..... • For zero calibration, set this ring to the “0-CAL” position to block entry of light into the probe.  
 For preparation :Set the ring to the “POINTER” position to cause the LED to emit a circle marker.  
 For measurement :Set the ring to the “MEAS” position to perform measurement.
- ③ Ring stopper ..... • Stops the ring at three positions.
- ④ Screw hole ..... • Used to secure the probe to a jig etc.
- ⑤ Plug ..... • Connect this plug to the probe connector on the main unit or that on the optional 4-Probe Expansion board (CA-B14).
- ⑥ Hood ..... • Used to prevent entry of ambient light and help you place the probe at the appropriate distance (30 mm) from the display and perpendicular to it.
- ⑦ Lens cap ..... • Used to protect the receptor.

---

# About Accessories

---

## Standard Accessories

---

- AC power cord (For 100-120V or 200-240 V)

Connect this cord to the AC power connector to supply power to the instrument.

For a description of how to connect, refer to page 28.

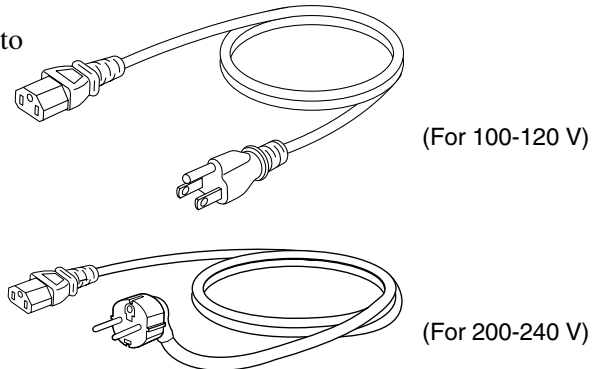

- Measuring probe(with a lens cap)
- Hood
- Color analyzer PC software CA-SDK
- Instruction manual

Read this manual before operating the instrument.

## Optional Accessories

---

- Universal Measuring probe CA-PU12/CA-PU15
- Small Universal Measuring probe CA-PSU12/CA-PSU15
- LCD Flicker Measuring probe CA-P12/CA-P15
- Small LCD Flicker Measuring probe CA-PS12/CA-PS15 (Page 12)

Connect the probes to the main body or the probe connectors on the 4-Probe Expansion Board before measurement.

### Location of the explanation

Connecting method: Page 26

Measuring method: Measurement Preparation, Setting, Measurement sections

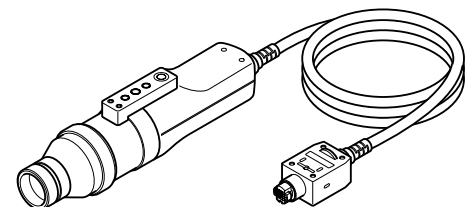

- 4-Probe Expansion Board

Connect measuring probes to this board, to allow simultaneous measurement of the colors at up to 5 points on the display's surface. It is possible to install Measuring Probes of all types to be coresident.

### Location of the explanation

Installation method: Page 27

Measuring method: Measurement Preparation, Setting, Measurement sections

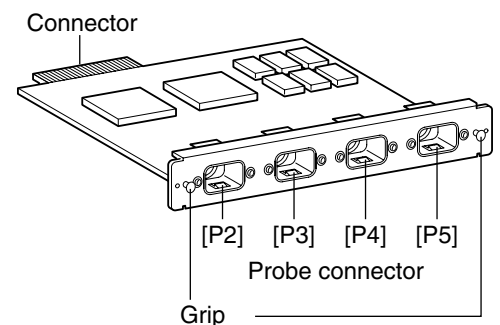

- Standard Hood for CA-210 CA-H10 / Small Hood for CA-210 CA-HS10
- Standard Lens cap for CA-210 CA-H11 / Small Lens cap for CA-210 CA-HS11

# About Measuring Probe

## Setting a Measuring Probe

Two types of screws are provided to secure the measuring probe.

Tripod screw: Used to mount the probe to a tripod. The screw depth is 6 mm.

ISO screw: Used to mount the probe to a jig. An ISO screw (5 mm, depth: 6 mm) can be used.

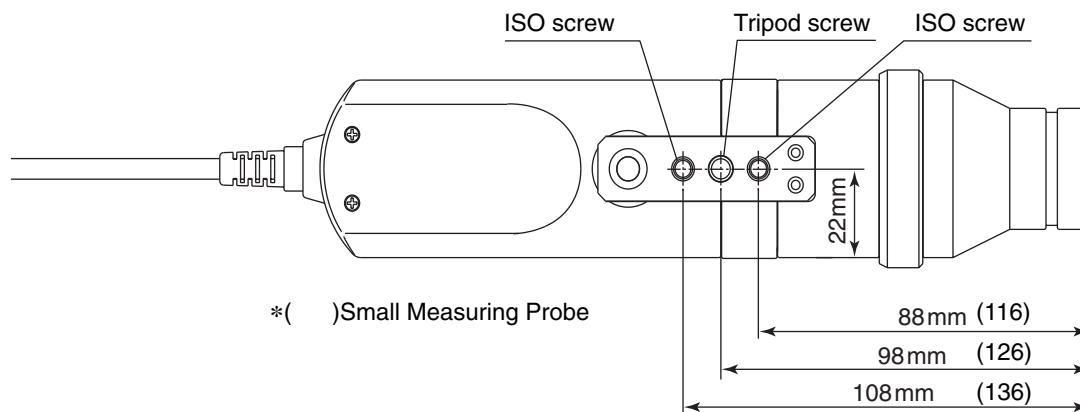

## Setting the Measuring Distance

1. Secure the display to be measured.
2. Set the pointing ring to the **POINTER** position.  
A circle marker will be emitted.
3. Check the area to be measured, make sure that the distance from the display surface to the tip of the probe is 30 mm, and secure the probe.

Make sure that the probe is placed perpendicular to the display surface.

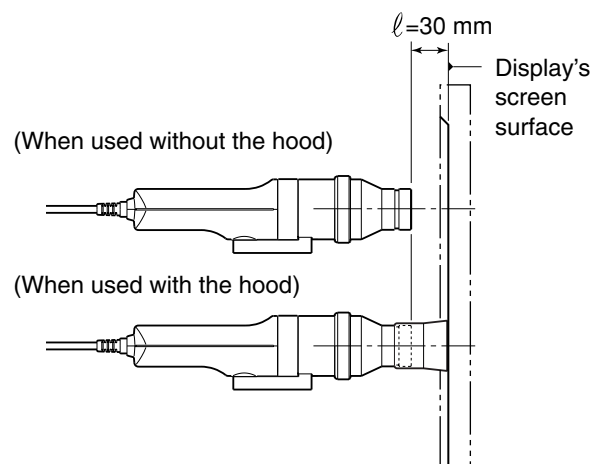

### <Caution>

- Measurement reproducibility becomes [the way which does not change the installation angle  $\theta$  for every measurement] high in measuring the high display of view angle dependability with the Small Measuring probe.
- Use of the hood (standard accessory) not only prevents entry of environmental light but also makes it easy to place the instrument at the specified distance and perpendicular to the object.
  - Universal Measuring probe(CA-PU12/15), LCD Flicker Measuring probe(CA-P12/15)  
:  $l=30\text{mm} \pm 10\text{mm}$ , accuracy is eternal.
  - Small Universal Measuring probe(CA-PSU12/15), Small LCD Flicker Measuring probe(CA-PS12/15)  
:  $l=30\text{mm} \pm 5\text{mm}$ , accuracy is eternal.

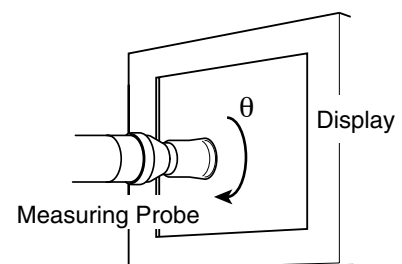



## About Pointing Ring

---

When you turn the pointing ring, it stops at three positions (MEAS, 0-CAL, POINTER). To turn the ring, the stopper must be pulled toward you to unlock it.

**MEAS** : To perform measurement, the ring must be set in this position.

**0-CAL** : To perform zero calibration, the ring must be set in this position.

Take care not to direct the measuring probe to a high-intensity light source.

**POINTER**: A red circle marker will be emitted from the LED. It may be difficult to see the marker depending on the surrounding brightness and intensity or color of the object. In this case, place a piece of white paper over the screen.

You must also take care not to stare into the probe while the marker is emitted.

Don't stare at the reflection of mirror surface.

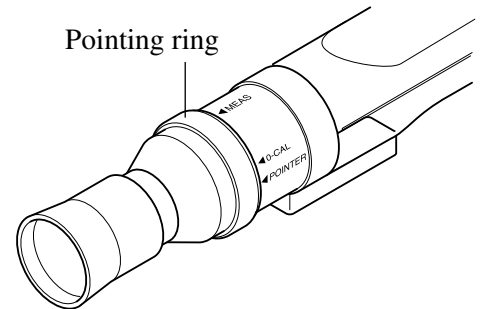

# Function of Each Key

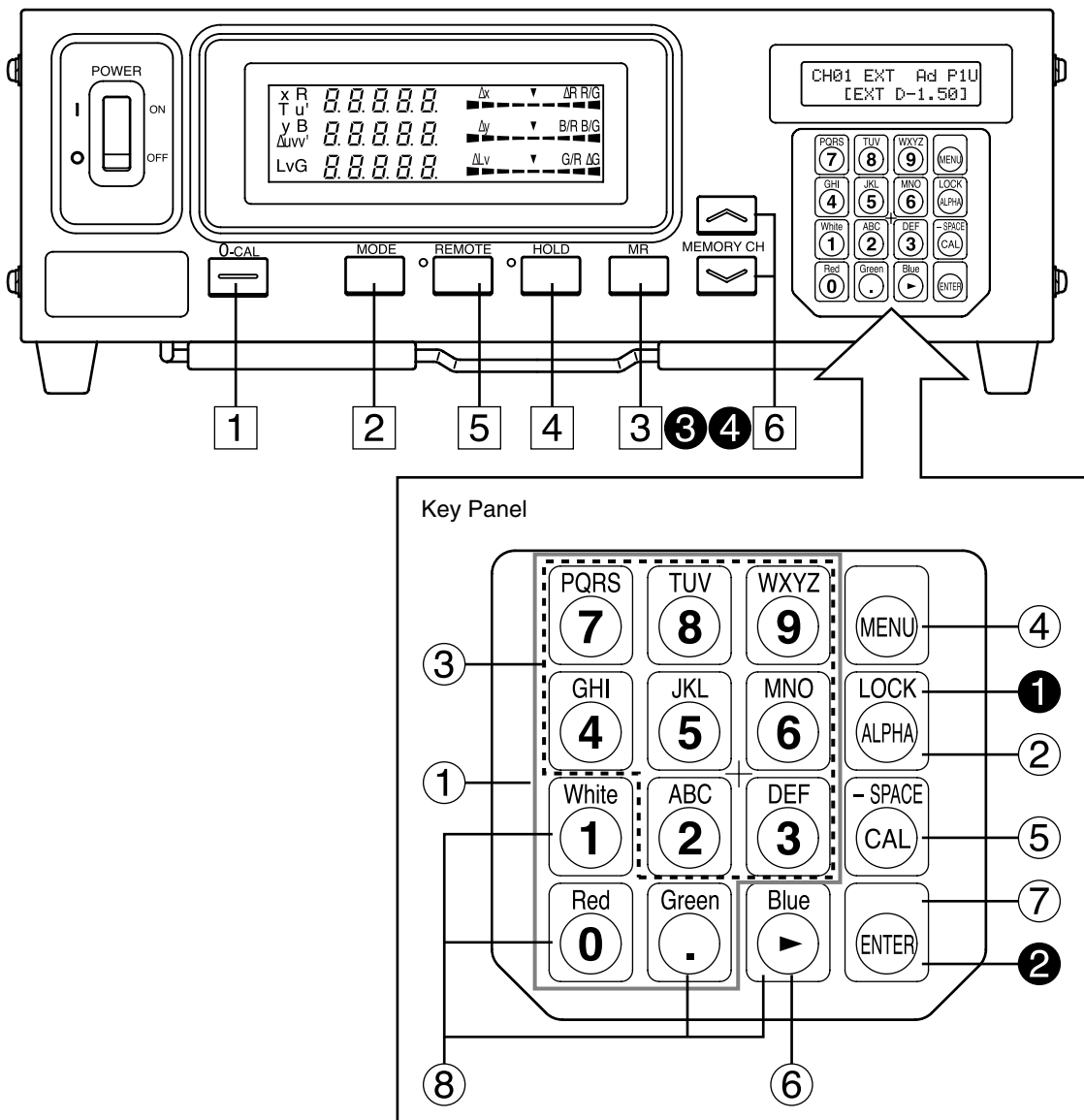

- 1** **0-CAL** key ..... • Performs zero calibration. Before pressing this key, make sure that the measuring probe is blocked from light. (Page 34)
- 2** **Mode** key ..... • Select measurement mode. (Page 38)

Measurement mode changes in the following order.

When Universal Measuring Probe(CA-PU12/15) or Small Universal Measuring probe(CA-PSU12/15) is connected,





Analyzer mode

xyLv→TΔuvLv→RBG (R/G, B/G, ΔG)→RBG (ΔR, B/G, G/R)→u'v'Lv→XYZ →xyLv









When LCD Flicker Measuring Probe(CA-P12/15) or Small LCD Flicker Measuring Probe(CA-PS12/15) is connected,

Analyzer mode

xyLv→TΔuvLv→RBG (R/G, B/G, ΔG)→RBG (ΔR, B/G, G/R)→u'v'Lv→Flicker\*\*→XYZ →xyLv
- 3** **MR** key ..... • Displays the specified target color in the LCD display section. (Page 74) (For long depression of this key, refer to page 17.)

- ④ **HOLD** key ..... • Holds the display of the measured value. (The HOLD LED will light up.)
- Pressing this key while the HOLD LED is lit will cancel hold mode. (The HOLD LED will go out.)
- ⑤ **REMOTE** key ..... • Sets the instrument in remote mode (i.e. communication with the PC is possible via RS-232C or USB). (The REMOTE LED will light up. See page 88)
- Pressing this key while the REMOTE key is lit will cancel remote mode. (The REMOTE LED will go out.)
- (Note) Remote mode should not be activated unless you are going to communicate with the PC.
- Otherwise, the other keys will be inoperative.
- ⑥ **MEMORY CH**  key ..... • Used to select a memory channel (CH00 to 99).  
 key  
 Pressing the  key will switch memory channel in the order “00→01→02... 98→99→00...”.
- Pressing the  key will switch memory channel in the order “00→99→98... 01→00→99...”.
- The memory channel switches from one to another each time the key is pressed, and switches continuously if the key is left held down.







### <Keys on Key Panel>





- ① Number-key (  ~ ,  ) ..... • Used to enter calibration data for user calibration (page 51), target color (page 62), ID name (page 67) and analog display range (page 69).
- ② ALPHA key (  ) ..... • Used to enter alphabets. This key enables you to use the number-key as alphabet keys. Pressing this key again will restore the original function of the ten-key.
- ③ Alphabet keys (  ~ ,  ) ..... • Used to enter alphabets for the ID name.
- ④ MENU key (  ) ..... • Switches the LCD display section to the menu selection screen. Pressing this key again will restore the original function of the LCD display section.
- ⑤ CAL key (  ) ..... **Normal Screen**
- When CH00 is selected as the memory channel  
You can enter a value for the target color. (Page 65)
  - When the memory channel other than CH00 is selected as the memory channel  
You can set CA-210 for input of WRGB data for user calibration. (Page 51)
  - When an analyzer measurement mode is selected  
You can set CA-210 for input of RGB emission characteristic and target color (W). (Page 59)  
This does not apply in the case of flicker mode\*\*.

### **Menu Selection Screen**

- Pressing the  key in the menu selection screen causes the screen to switch as follows.  
 PROBE selection → SYNC selection → ID Name input → RANGE setting → Measurement Speed selection → Number of Digits setting → Calibration Standard selection → RS232C Baud Rate selection → PROBE selection

\*\*Flicker Mode is a function which can be used only when LCD Flicker Measuring Probe(CA-P12/15) or Small LCD Flicker Measuring Probe (CA-PS12/15) is connected.

- ⑥ Cursor key (  ) ..... • Used to switch from one option to another in the PROBE, SYNC, Measurement Speed, Number of Digits, and RS232C baud rate screens, which are opened from the menu selection screen.
- ⑦ ENTER key (  ) ..... • Used to confirm each setting/selection you have made.
- ⑧ White, Red, Green, ..... • Used to set RGB emission characteristics of the display.  
Blue keys (     )

- ① Holding down the  key ..... Locks all the keys except for the  key. Holding down this for two seconds or more ..... key again for two seconds or more will unlock the keys.  
(Whistling sound.)
  - ② Holding down the  key ..... Stores the current settings (probe, SYNC, memory channel, measurement mode) to the instrument. The settings will be effective when the power is for five seconds or more ..... turned on next time.  
(Bleeping sound. A whistling sound is heard when the setting is saved.)
  - ③ Holding down the  key ..... **When xyLv, TΔuvLv or XYZ measurement mode is selected**  
for two to four seconds ..... Displays serial number of the probe in use at the time calibration to  
(Bleeping sound.) ..... a user selected reference was performed and the target color were set. (Page 74)
- When an analyzer mode is selected**  
Displays serial number of the probe in use at the time RGB emission characteristics of the display and the target color (W) were set. (Page 74)
- When flicker mode\*\* is selected**  
“00000000” will be displayed. (Page 74)
- ④ Holding down the  key ..... The unit of luminance will be displayed. (cd/m<sup>2</sup> or fL)  
for four seconds or more .....  
(Bleep sounds two seconds later and then four seconds later.)

\*\*Flicker Mode is a function which can be used only when LCD Flicker Measuring Probe(CA-P12/15) or Small LCD Flicker Measuring Probe(CA-PS12/15) is connected.

# About Display

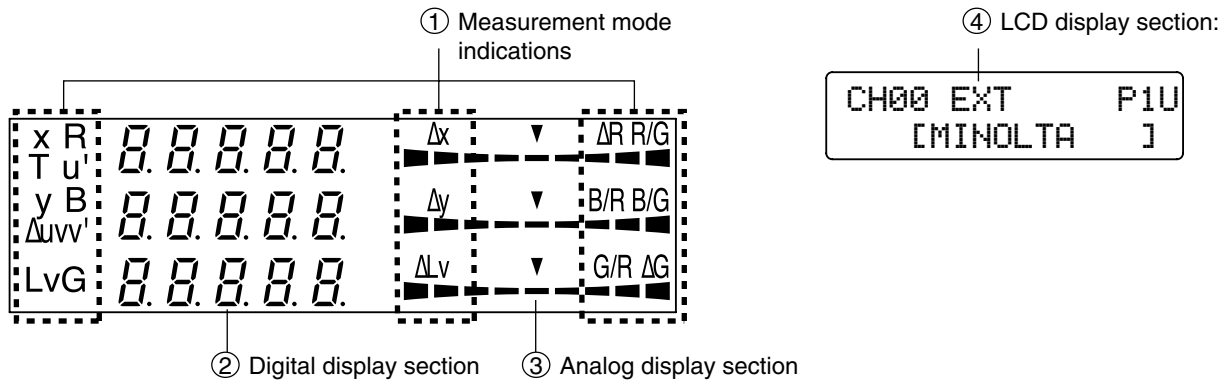

\* This shows when the entire display area is lit. (The LCD display section is not shown.)

① Measurement mode ..... Displays the measurement mode in which the measured values are displayed.

Measurement mode switches from one to another as shown below each time the **[MODE]** key is pressed. (Page 40)

When Universal Measuring Probe(CA-PU12/15) or Small Universal Measuring probe(CA-PSU12/15) is connected,

xyLv → TΔuvLv → RBG (R/G, B/G, ΔG) → RBG (ΔR, B/G, G/R) → u'v'Lv → XYZ → xyLv

When LCD Flicker Measuring Probe(CA-P12/15) or Small LCD Flicker Measuring Probe(CA-PS12/15) is connected,

xyLv → TΔuvLv → RBG (R/G, B/G, ΔG) → RBG (ΔR, B/G, G/R) → u'v'Lv → Flicker\*\* → XYZ → xyLv

② Digital display section ..... Displays the measured values.

- When xyLv measurement mode is selected  
x, y and Lv are displayed.

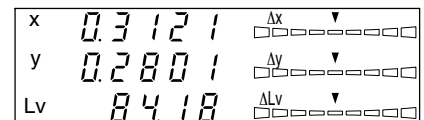

- When TΔuvLv measurement mode is selected  
T, Δuv and Lv are displayed.

T (correlated color temperature) is displayed in three significant digits.

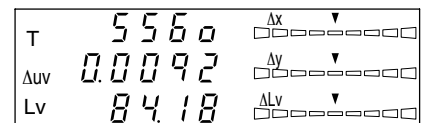

- When an analyzer measurement mode is selected

R, B and G are displayed. R-reference and G-reference are available. (The same contents are displayed in the digital display area, whether R-reference or G-reference.)

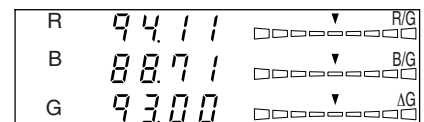

- When u'v'Lv measurement mode is selected

u', v' and Lv are displayed.

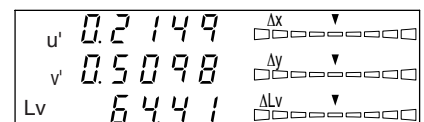

- When flicker measurement mode\*\* is selected

Flicker\*\* is displayed. The display range is from 0.0 to 100.0%.

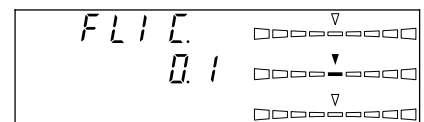

- When XYZ measurement mode is selected

X, Y and Z are displayed. (X, Y and Z from top to bottom)

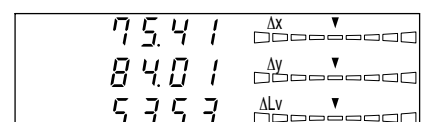

③ Analog display section ..... Displays the difference (%) between the measured value and the target color or the difference (%) between measured values.  
The range for each dot can be set between 0.1 and 99%. (Page 69)

- How to read/when the range is set in “n” % except flicker mode  
For a description of flicker mode refer to page 69.

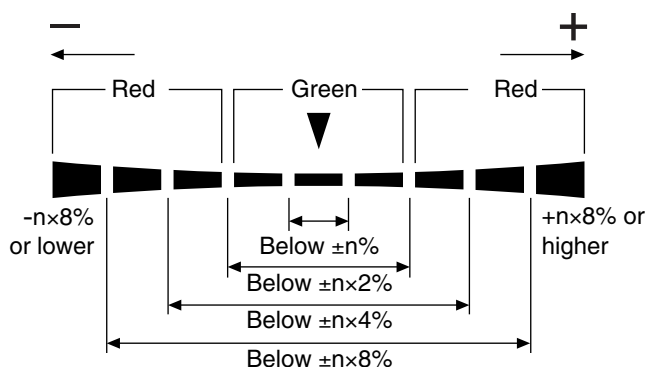

The range has been set to 10% prior to factory shipment.

- When xylv, TΔuvLv, u'v'Lv or XYZ measurement mode is selected  
Δx, Δy and ΔLv are displayed.

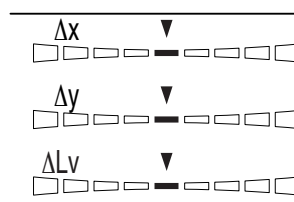

- When an analyzer measurement mode is selected  
For G-reference R/G, B/G and ΔG are displayed.  
For R-reference ΔR, B/R and G/R are displayed

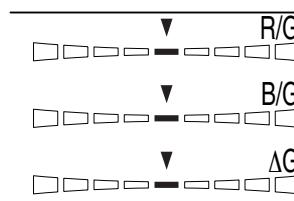

- When flicker mode\* \*is selected Flicker is displayed.

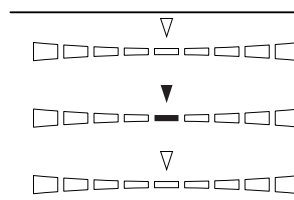

④ LCD display section ..... Displays the memory channel, probe no., ID name, warning and settings.

In case of error, an error message will appear.

(For a description of what to do in case of error, refer to page 103.)

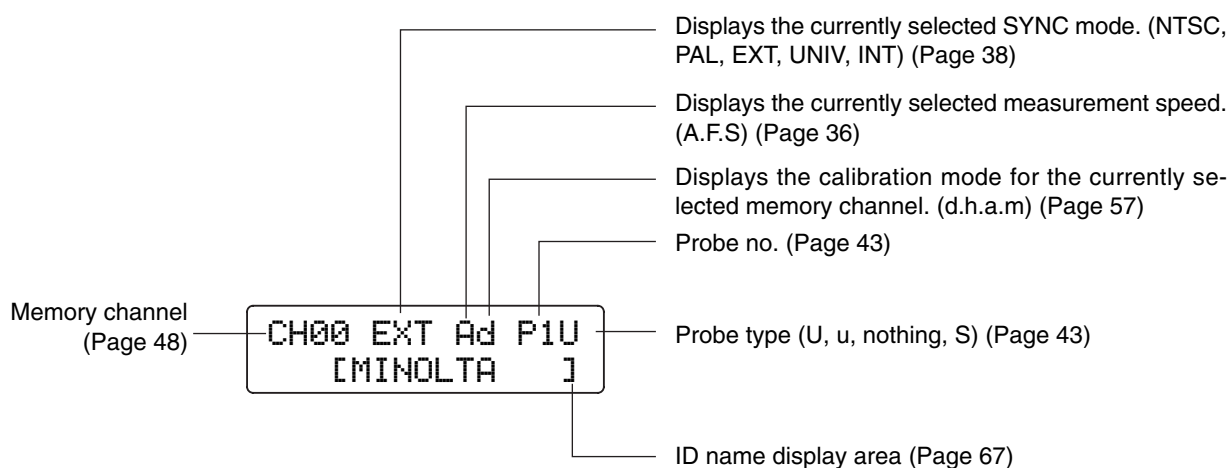

## <Out of Measurement Range>

### [For xylv, T $\Delta$ uvLv, u'v'Lv or XYZ,Analyzer Mode]

- When the measurement range is exceeded  
Digital display : “-----”  
Analog display : Not lit  
LCD display : “OVER”

### [For T $\Delta$ uvLv Mode]

- T or  $\Delta$ uv are out of the display range  
Digital display : “-----”  
(T and  $\Delta$ uv)

### [For Flicker Mode\*\*]

- When the measured value has exceeded 100.00%  
Digital display : “-----”  
Analog display : Not lit  
LCD display : “FLICKER ERROR OVER”
- When Lv(luminance) is the following  
under 0.1cd/m<sup>2</sup> for LCD Flicker Measuring Probe (CA-P12/15)  
under 0.3cd/m<sup>2</sup> for Small LCD Flicker Measuring Probe (CA-PS12/15)  
Digital display : “-----”  
Analog display : Not lit  
LCD display : “FLICKER ERROR UNDER”

## <About Low-Luminance Warning>

### [For xylv, T $\Delta$ uvLv, u'v'Lv or XYZ,Analyzer Mode]

- When Lv (luminance) is under the following minimum values (white calibration equivalent to Konica Minolta's calibration standard)  
under 0.1 cd/m<sup>2</sup> for Universal Measuring Probe(CA-PU12/15) and LCD Flicker Measuring Probe(CA-P12/15)  
under 0.3 cd/m<sup>2</sup> for Small Universal Measuring Probe(CA-PSU12/15) and Small LCD Flicker Measuring Probe(CA-PS12/15)  
Digital display : blinking  
Analog display : blinking  
Measurement mode : blinking

### [For Flicker Mode\*\*]

- When Lv(luminance) is the following (Konica Minolta's white calibration standard)  
under 5cd/m<sup>2</sup> for LCD Flicker Measuring Probe (CA-P12/15)  
under 15cd/m<sup>2</sup> for Small LCD Flicker Measuring Probe (CA-PS12/15)  
Digital display : blinking  
Analog display : blinking  
Measurement mode : blinking

\*\*Flicker Mode is a function which can be used only when LCD Flicker Measuring Probe(CA-P12/15) or Small LCD Flicker Measuring Probe(CA-PS12/15) is connected.





# Installation/Connection

---

This section explains how to install the instrument, connect AC power, turn ON (I)/OFF(O) the power, and input the vertical synchronizing signal.

<p><b>About Installation</b> Provides operating environmental conditions for the instrument and notes on installation.</p>	Page 25
↓	
<p><b>About Connection</b> Explains how to connect measuring probes and connect the power cord. (It also explains installation method of the optional 4-Probe Expansion Board.)</p>	Page 26
↓	
<p>* Before turning on the power : Refer to pages 85 to 88 if you are going to communicate the instrument with the PC via RS-232C or USB.</p>	
<p><b>Turning the Power ON (I)/OFF(O)</b> Explains how to turn ON (I)/OFF(O) the power.</p>	Page 29



## SAFETY WARNING

(Failure to adhere to the following points may result in death or serious injury.)



Do not use the instrument in areas where flammable or combustible gases (gasoline fumes etc.) are present.



Doing so may result in a fire.



If dust has entered through the vents and collected inside the instrument, do not use the instrument.



Doing so may result in a fire.

For periodic inspection, contact a Konica Minolta authorized service facility.



Always use the AC power cord supplied as a standard accessory with the instrument, and connect it to an AC outlet (100-240V~, 50-60 Hz).



Connecting to a voltage other than that specified may result in damage to the instrument, fire or electric shock.



• Do not bend, twist or pull the AC power cord excessively.



• Do not place heavy items on the AC power cord or scratch it.



• Do not modify the AC power cord.

Doing so may damage it, resulting in fire or electric shock.



When disconnecting the AC power cord's plug, always hold the plug and pull it to remove it. Never pull the AC power cord itself as it may be damaged, resulting in fire or electric shock.



Also do not insert or disconnect the AC power cord's plug with wet hands. Doing so may cause electric shock.



If you are not going to use the instrument for a long time, disconnect the AC power cord from the AC outlet. Dirt or water may accumulate on the prongs of the AC power cord's plug and it may cause a fire. If there is any dirt or water on the prongs, it must be removed.



## SAFETY PRECAUTIONS

(Failure to adhere to the following points may result in injury or damage to the instrument or other property.)



- Do not place the instrument on an unstable or sloping surface.
- When you carry the product, take care not to let it drop.

Doing so may result in its dropping or overturning, causing injury.



Be sure to connect the AC power cord's plug to an AC outlet that has a protective grounding terminal.



Also make sure that peripheral devices (e.g. PC) are connected to AC outlets that have a protective grounding terminal.



Failure to do so may result in electric shocks.

---

# About Installation

---

The operating environmental requirements are given in the “Specifications” of this manual. The instrument must be installed in a place that completely meets these requirements. (Page 110-113)

## <Notes on Installation>

- Using the instrument in direct sunshine in midsummer or near a heater will cause a rapid rise in its temperature resulting in breakdown.  
Special care must be taken when handling the instrument in such an environment. In addition, take care not to allow the vents to become blocked. Do not use the instrument in poorly ventilated areas.
- Do not use the instrument in a place where the temperature changes rapidly, since measured values will be incorrect.
- The instrument must not be used in areas where there is an excessive amount of dust or where the humidity is excessively high.
- The instrument must not be used if foreign matter such as water and metal objects enter it, doing so is very dangerous.
- The AC power cord must not be pulled or bent excessively nor must excessive force be exerted on it. Doing so may result in wire breakage.
- The AC power cord must not be connected to an AC line on which excessive noise is present.
- If any irregularity or abnormality is found, turn OFF(○) the power immediately, disconnect the AC power cord, and refer to “Troubleshooting Guide” on page 107.

---

# About Connection

---

## 1. Connecting a Measuring Probe

---

Before setting the POWER switch to ON (I), a measuring probe must be connected to the probe connector [P1] on the instrument.

### [Connecting Method]

---

**1. Set the POWER switch to OFF (“O” position).**

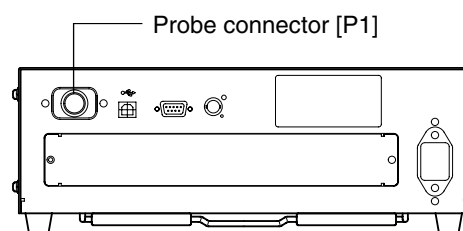

**2. Insert the probe's plug into the probe connector [P1], with the probe serial no. facing down.**

**3. Check that the plug is inserted all the way and connected firmly**

- When disconnecting the measuring probe, set the POWER switch to OFF(O) first, and pull the probe by holding the plug. Never pull the probe by its cord.

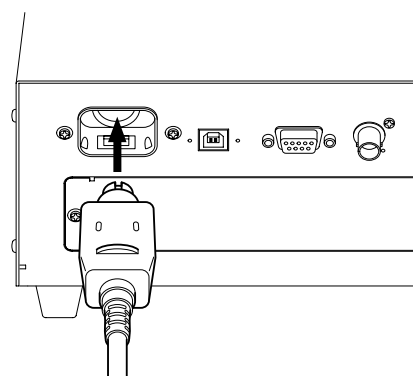

### <Notes when Connecting the Probe>

- Never connect or remove the measuring probe while the POWER switch is ON (I).
- When connecting/disconnecting the measuring probe, always hold the plug and connect/disconnect it. In addition, do not pull or bend the cord excessively or exert excessive force on it. Doing so may result in wire breakage.
- The Measuring Luminance Range will vary according to the type of Measuring Probe.
- When measurement is implemented, the same Measuring Probe to be used for the User Calibration is necessary. If measurement is carried out by connecting the different Measuring Probe, error message E1 will be displayed.

## 2. Installing the 4-Probe Expansion Board

When the optional 4-Probe Expansion Board CA-B14 is used

Installing the optional 4-Probe Expansion Board CA-B14 in the instrument allows simultaneous measurement of the colors or flicker\*\* at up to 5 points on the display's surface. Install the expansion board as shown below.

### [Installation Method]

#### 1. Remove the cover of the 4-Probe Expansion Board slot.

- ① Set the POWER switch on the instrument to OFF(○).
- ② Remove the two screws from the slot cover, and remove the cover.

#### 2. Install the 4-Probe Expansion Board.

- ① Place the 4-Probe Expansion Board along the right- and left-side guides in the slot.
- ② Push the board all the way and make sure that the board is connected properly.
- ③ Secure the board with the two screws that were removed previously.
  - Repeatability of the measurement value becomes worse when the fixation by the screw is incomplete.
  - To remove the board, remove the two screws first, then hold the grip of the board and pull it out. After the board is removed, attach the cover to the slot.

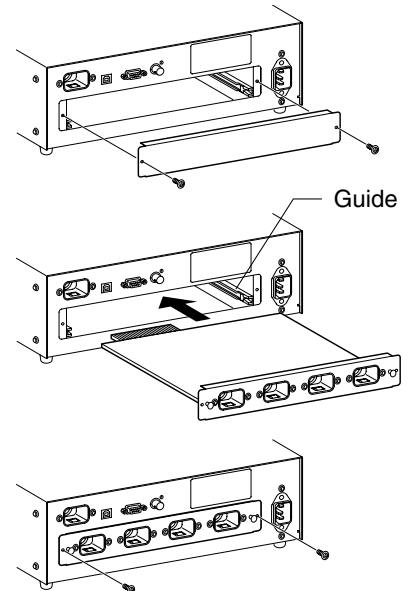

### <Notes on Installation>

- When installing/removing the 4-Probe Expansion Board, always set the POWER switch to OFF(○) and pull the AC power cord from the AC outlet first.
- Do not touch the connectors (gold plated parts) or ICs on the 4-Probe Expansion Board with your hands. If oil or similar matter adheres to the connectors, wipe them with a soft, dry cloth.

### <Connecting Measuring Probes>

The following 8 types of measuring probes can be connected.

- Universal Measuring Probe CA-PU12 /CA-PU15
- Small Universal Measuring Probe CA-PSU12/CA-PSU15
- LCD Flicker Measuring Probe CA-P12 /CA-P15
- Small LCD Flicker Measuring Probe CA-PS12 /CA-PS15

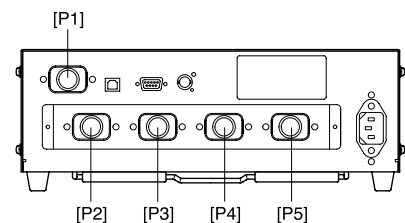

A total of five probes can be connected. When connecting two or more probes, always make sure that one of them is connected to the probe connector [P1].

Connect necessary number of probes to the probe connectors [P2] to [P5] on the 4-Probe Expansion Board. You do not have to connect any probes to those connectors ([P2] to [P5]). Probes can be connected to any connectors ([P2] to [P5]). The Measuring Luminance Range will vary according to the type of Measuring Probe.

6 types of optionally available Measuring Probes can be connected.

As a display model to be measured and the Measuring Luminance Range of Measuring Probe will vary according to the type, please install one that is fit for your use. Also, different types can be coresident.

- The connecting method for connectors [P2] to [P5] is the same as that for [P1]. (Refer to page 26.)

**Notes when connecting probes:** Probe connectors on the 4-Probe Expansion Board where no probe is connected must be capped.

\*\*Flicker Mode is a function which can be used only when LCD Flicker Measuring Probe(CA-P12/15) or Small LCD Flicker Measuring Probe(CA-PS12/15) is connected.

When the optional 4-Probe Expansion Board CA-B14 is used

In Flicker Mode with LCD Flicker Measuring Probe(CA-P12/15) or Small LCD Flicker Measuring Probe(CA-PS12/15) connected, a selected probe cannot be changed to Universal Measuring Probe(CA-PU12/15) or Small Universal Measuring Probe(CA-PSU12/15).

### 3. Connecting the Power

Power voltage range for the instrument — 100 to 240V $\sim$

#### [Connection Method]

1. Set the POWER switch to OFF (“○” position).
2. Connect the AC power cord’s connector to the AC power connector on the instrument.  
The AC power cord must be connected as shown in the figure.
3. Insert the AC power cord’s plug to an AC outlet.

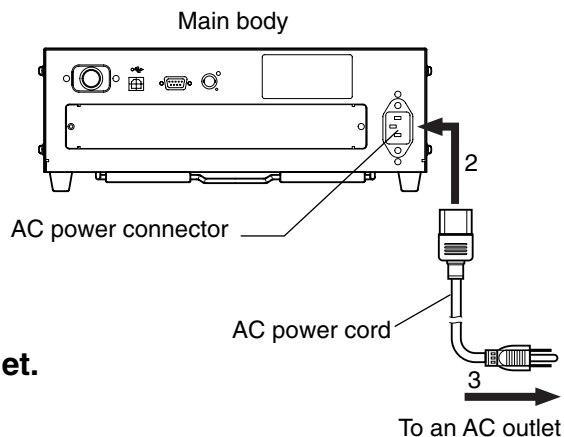

#### <Notes on Power Connection>

- Never connect or remove the AC power cord while the POWER switch is ON.
- When connecting/disconnecting the AC power cord, always hold the plug and connect/disconnect it. In addition, do not pull or bend the cord excessively or exert excessive force on it. Doing so may result in wire breakage.
- Be sure to connect the AC power cord’s plug to an AC outlet that has a protective grounding terminal.

### 4. Inputting the Vertical Synchronizing Signal

The vertical synchronizing signal from the display can be input to the instrument to allow synchronous measurement (when EXT SYNC mode is selected).

**However, if another SYNC mode is selected, it is not necessary to input the vertical synchronizing signal.**

Connect the BNC cable of the vertical synchronizing signal (frequency: 40 to 200 Hz) used for the display to the connector on the rear panel of the instrument as shown below. Before connecting, make sure that the power to both the instrument and display is turned OFF.

In the case of flicker mode, a vertical synchronizing signal of 40 to 130 Hz must be input.

(Only when LCD Flicker Measuring Probe(CA-P12/15) or Small LCD Flicker Measuring Probe(CA-PS12/15) is connected.)

Circuit diagram

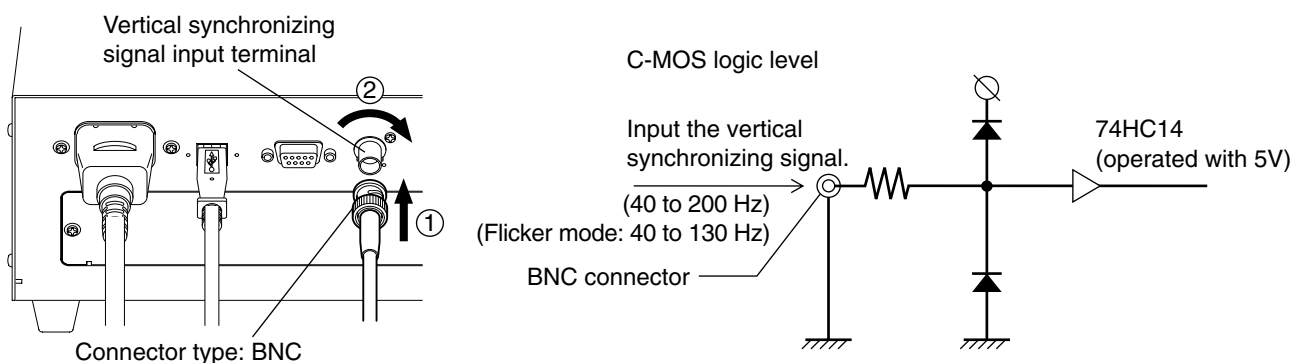

\* To synchronize measurement with the display’s vertical synchronizing signal, EXT must be selected as the SYNC mode. For details, refer to page 36.

# Turning the Power ON ( | )/OFF ( ○ )

## 1. Turning the Power ON ( | )/OFF ( ○ )

Before setting the POWER switch to ON ( | ), prepare the following.

### 1. Connect a measuring probe to the probe connector [P1]. (Page 26)

- To synchronize measurement with the ...<sup>①</sup> Input the vertical synchronizing signal that is used for the display. display's vertical synchronizing signal (Page 28) (EXT is selected as the SYNC mode)
- To perform measurement .....<sup>①</sup> Install the 4-Probe Expansion Board (option) in the instrument. (Page 27)  
 with two or more measuring probes <sup>②</sup> Connect necessary number of probes to the probe connectors [P2] to [P5]. (Pages 26 and 27)
- To communicate with the PC .....<sup>①</sup> Connect the instrument's RS-232C connector to the PC. (Page 86) via RS-232C
- To communicate with the PC via USB...<sup>①</sup> Connect the instrument's USB connector to the PC. (Page 88)

### 2. Connect the AC power cord to an AC outlet. (Page 28)

#### [Turning the Power ON ( | )]

Set the POWER switch to ON ( | ).

If the instrument is connected to external equipment, set the instrument's POWER switch to ON ( | ) first, then turn ON ( | ) the power to the external equipment.

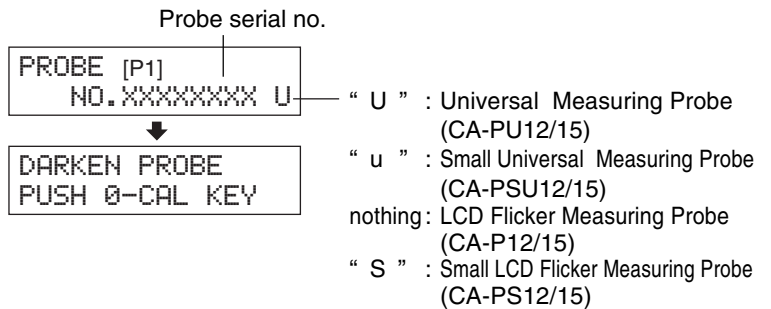

#### [Turning the Power OFF ( ○ )]

If the instrument is connected to external equipment, turn OFF ( ○ ) the power to the external equipment first, then set the instrument's POWER switch to OFF ( ○ ).

**<Error Messages in LCD Display Section>** ... For other error messages, refer to page 101.

- “SET MAIN PROBE” (After the POWER switch is set to ON ( | ))
 

SET MAIN PROBE

  - Cause 1 : The measuring probe is not connected to the probe connector [P1] properly.
  - Action 1: Set the POWER switch to OFF ( ○ ), then connect the measuring probe to the probe connector [P1] properly. (Before connecting/disconnecting the measuring probe, make sure that the POWER switch is set to OFF ( ○ ).)
- “PROBE ERROR”
 

PROBE ERROR

  - Cause 1 : A measuring probe was connected or disconnected while the POWER switch was ON ( | ).
  - Action 1: Set the POWER switch to OFF ( ○ ) first, connect necessary measuring probes, then set the POWER switch to ON ( | ). (Before connecting/disconnecting the measuring probe, make sure that the POWER switch is set to OFF ( ○ ).)

## 2. Instrument Status at Power-ON

The instrument has been set prior to factory shipment so that it will be set as follows when the POWER switch is set to ON.

① Measurement mode	Page 40	xyLv mode
② Memory channel no.	Page 48	CH00
③ Target color	Page 63	x = 0.3127 y = 0.3293 Lv = 160.0 (cd/m <sup>2</sup> )
④ PROBE	Page 43	P1
⑤ SYNC mode	Page 36	EXT mode
⑥ ID name	Page 67	Consists of Blank spaces only.
⑦ Analog display range value	Page 69	10% (all ranges)
⑧ Measurement speed	Page 36	AUTO
⑨ Number of display digits	Page 42	4 digits
⑩ Calibration standard	Page 50	6500K Konica Minolta's standard data
⑪ RS232C baud rate	Page 87	38400bps
⑫ Calibration data (stored) in CH00 to CH99	Page 51	6500K Konica Minolta's standard data
⑬ Luminance unit	Page 32	cd/m <sup>2</sup>

### <Changing the Instrument Status at Power-ON>

Change necessary parameters and press the  key for more than five seconds. A bleep will sound, followed by a whistling sound when the settings are saved. The instrument will start with the new settings when the power is turned ON next time. (The selected mode and memory channel etc. will be stored in the instrument's memory, and they will remain effective even if the POWER switch is set to OFF.) \* For details, refer to the pages given in the above table.

#### **Changing Method for parameters ① and ②**

① Measurement mode ..... Press the  key.

② Memory channel ..... Press the CH  and  keys.

#### **Changing Method for parameter ③**

③ Target color value ..... The current target color will be changed if you select a mode other than flicker and then enter a target color, or select user calibration or enter the RGB emission characteristic for analyzer mode.



## Changing Method for parameters ④ to ⑪

For parameters ④ to ⑪, switch the LCD display section to the menu selection screen as explained below.

### 1. Press the key.

The LCD display section will switch to the menu selection screen.

### 2. Press the key until the desired screen is displayed.

Each time the  key is pressed, the screen will switch in the order PROBE→SYNC→ID Name input→RANGE→Measurement Speed→Number of Digits→Calibration Standard data→RS232C Baud Rate→PROBE.

### 3. Press the key to select the desired setting, and press the key to confirm the selection.

For the ID name and range, enter the desired settings using the ten-key, ALPHA and alphabet keys, then press the  key to confirm the settings.

## Changing Method for parameter ⑫⑬

For the setting method, refer to the page given in the above table.

## <About the Key>

The  key should not be pressed unless you are going to communicate with the PC via RS-232C or USB.

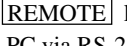
- Pressing the  key sets the instrument in remote mode, enabling communication with the PC via RS-232C or USB.

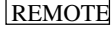
(The REMOTE LED will light up.) In remote mode, no keys other than the  key are effective.

To cancel remote mode, press the  key again.

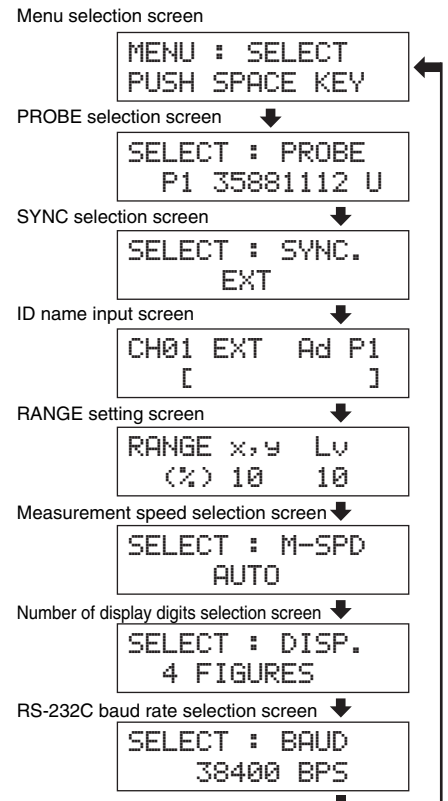

### 3. About the change of Luminance Unit

---

This instrument allows you to switch the unit for the displayed luminance between “cd/m<sup>2</sup>” or “fL”. The method is given below.

**1. Set the POWER switch to ON while holding down the **MODE** key.**

“\*” will appear.

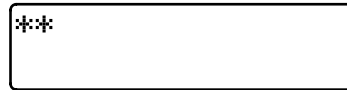

.  
.  
.

“\*” will be added one after another as shown.



**2. Press the  key before a total of sixteen asterisks appear.**

Keeping the  key held down will display as shown below, switching the luminance unit from one to another.

Unit before	Unit after
fL	→ cd/m <sup>2</sup>
cd/m <sup>2</sup>	→ fL



The newly set luminance unit will remain unchanged until it is changed again by the above method, even if the power is turned OFF.

\* At the time of shipment, the luminance unit is set as cd/m<sup>2</sup>.

# Measurement Preparation

The Measurement Preparation section explains preparations (instrument setting, zero calibration) that are required prior to measurement.

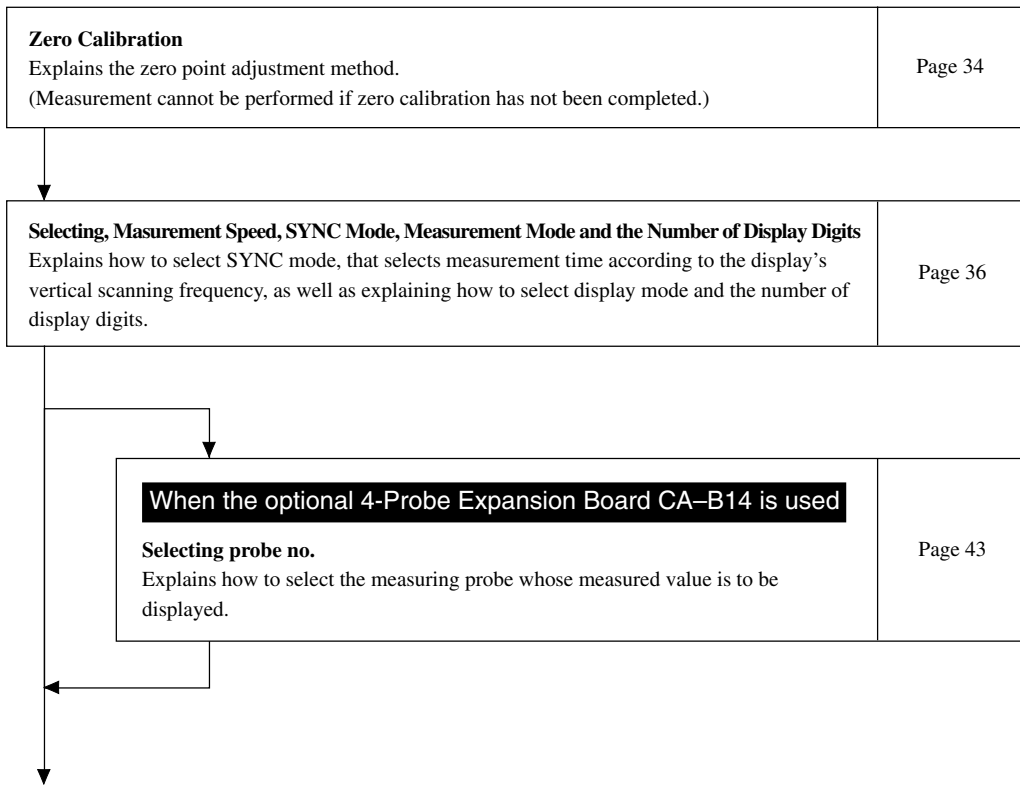

## To the Setting section

\* Go to the Measurement section if you are going to perform measurement using Konica Minolta's calibration standard and are not going to use analog display.

# Zero Calibration

Zero calibration performs zero point adjustment while blocking entry of light into the measuring probe's receptor. Zero calibration must be performed whenever the POWER switch is set to ON.

## 1. Performing Zero Calibration

### <Notes on Zero Calibration>

- If the luminance of the display to be measured is 1.0 cd/m<sup>2</sup> or less (if Small Universal Measuring Probe(CA-PSU12/15) or Small LCD Flicker Measuring Probe(CA-PS12/15), 3.0 cd/m<sup>2</sup> or less), perform zero calibration after elapse of 30 minutes or more after the POWER switch is set to ON.  
When measuring such a low-luminance display for a long period of time, perform zero calibration approximately every hour.
- Perform zero calibration if the ambient temperature has changed.
- Zero calibration can be performed anytime even if "PUSH 0-CAL KEY" is not displayed.
- Never direct the measuring probe toward the illuminant with illuminance exceeding the measurement range during zero calibration.
- Never press any keys during zero calibration. Doing so will cause completion of zero calibration to take more time.
- **When the optional 4-Probe Expansion Board CA-B14 is used**  
Zero calibration will be performed simultaneously with all the connected measuring probes.

### [Operating Procedure]

Before starting zero calibration, check that a measuring probe is connected to the probe connector [P1] on the instrument.

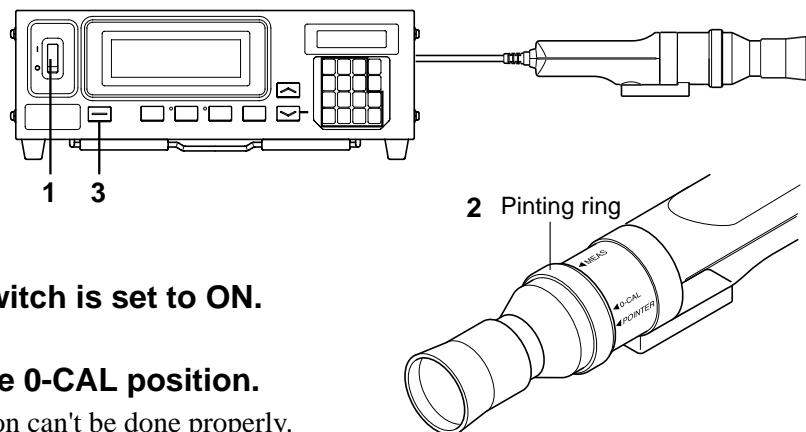

**1. Check that the POWER switch is set to ON.**

**2. Set the pointing ring to the 0-CAL position.**

Be careful because zero calibration can't be done properly.

- Don't turn the tip of Probe to the high illuminant with illuminance exceeding the measurement range.
- Don't carry out zero calibration under the condition that the pointing-ring is set in "POINTER".

### **When the optional 4-Probe Expansion Board CA-B14 is used**

Set the switching ring of every measuring probe to the 0-CAL position. Zero calibration will not be performed correctly if the switching ring of any of the measuring probes is not set to the 0-CAL position.

DARKEN PROBE  
PUSH 0-CAL KEY

Message displayed when the POWER switch is set to ON

ZERO CALIBRATION

Press the 0-CAL key.

During zero calibration

CH00 EXT Fd P1  
E1 [ ]

End of zero calibration

"E1" is always displayed if the instrument is used for the first time since shipment from the factory.

**3. Press the 0-CAL key.**

Measurement will start automatically at the end of zero calibration.

**<Error Messages in LCD Display Section>** ... For other error messages, refer to page 103.

- “TOO BRIGHT” (During zero calibration)
  - Cause : Light is entering the measuring probe’s receptor.
  - Action : Block the light completely, and when “PUSH 0-CAL KEY” appears press the 0-CAL key again to start zero calibration.

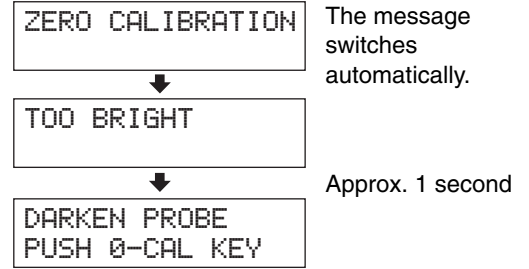

- “E1” (After completion of zero calibration)
  - Cause : “E1” is displayed if the instrument is used for the first time since shipment from the factory, because no target color has been set.
  - For other cases, refer to page 103.

```

    CH00 EXT  Ad P1
    E1 [      ]
  
```

## 2. Zero Calibration Check Method

If you want to check whether zero calibration has been performed correctly, block entry of light into the measuring probe’s receptor using a blackout curtain etc.

- If the message shown on the right appears in the LCD display section, perform zero calibration again.
- Zero calibration has been completed correctly if “000” blinks for “Lv” in the digital display section. If a value other than “000” is displayed, perform zero calibration again.

```

    OFFSET ERROR
    PUSH 0-CAL KEY
  
```

(Note) Even if “OFFSET ERROR” is displayed, measurement will start if the measuring probe’s receptor is exposed to light.

# Selecting, Measurement Speed, SYNC Mode, Display Mode and the Number of Display Digits

## 1. Selecting the Measurement Speed

Select the measurement speed according to your application.

If the measurement speed is changed, display frequency of the measurement results will change accordingly.

The measurement results are displayed at the following frequency.

### FAST mode

Requires short measurement time, but measurement accuracy is not sufficient in the case of measurement of a low-intensity display.

### SLOW mode

Repeats measurement in FAST mode five times, and displays the average of the five measured values. This mode is used when you want to perform accurate measurement.

### AUTO mode

Switches measurement speed to FAST or SLOW automatically according to the luminance of the display measures. Normally, this measurement speed is recommended.

The measurement speed switches from FAST to SLOW or vice versa at the following luminance .

(Universal Measuring Probe) FAST → SLOW :When Lv drops below 4.0cd/m<sup>2</sup>.

(CA-PU12/15) SLOW → FAST :When Lv exceeds 6.0cd/m<sup>2</sup>.

(Small Universal Measuring Probe) FAST → SLOW :When Lv drops below 12.0cd/m<sup>2</sup>.

(CA-PSU12/15) SLOW → FAST : When Lv exceeds 18.0cd/m<sup>2</sup>.

(LCD Flicker Measuring Probe) FAST → SLOW : When Lv drops below 2.0cd/m<sup>2</sup>.

(CA-P12/15) SLOW → FAST : When Lv exceeds 3.0cd/m<sup>2</sup>.

(Small LCD Flicker Measuring Probe) FAST → SLOW : When Lv drops below 6.0cd/m<sup>2</sup>.

(CA-PS12/15) SLOW → FAST : When Lv exceeds 9.0cd/m<sup>2</sup>.

(In the case of Flicker Mode\*\*, the measurement speed is always FAST mode.)

### When the optional 4-Probe Expansion Board CA-B14 is used

(Universal Measuring Probe) FAST → SLOW : When Lv for any of probes drops below 4.0 cd/m<sup>2</sup>.

(CA-PU12/15) SLOW → FAST : When Lv for all the probes exceed 6.0 cd/m<sup>2</sup>.

(Small Universal Measuring Probe) FAST → SLOW : When Lv for any of probes drops below 12.0 cd/m<sup>2</sup>.

(CA-PSU12/15) SLOW → FAST : When Lv for all the probes exceed 18.0 cd/m<sup>2</sup>.

(LCD Flicker Measuring Probe) FAST → SLOW : When Lv for any of probes drops below 2.0 cd/m<sup>2</sup>.

(CA-P12/15) SLOW → FAST : When Lv for all the probes exceed 3.0 cd/m<sup>2</sup>.





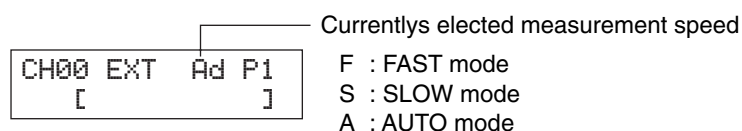

(Small LCD Flicker Measuring Probe) FAST → SLOW : When Lv for any of probes drops below 6.0 cd/m<sup>2</sup>.

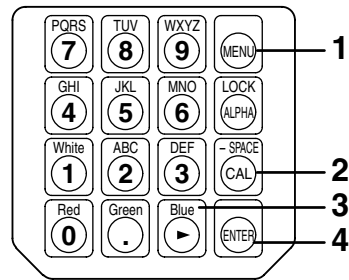
(CA-PS12/15) SLOW → FAST : When Lv for all the probes drops exceed 9.0 cd/m<sup>2</sup>.



## [Operating Procedure]



- 1. Press the  key.**  
The LCD display section will switch to the menu selection screen.
- 2. Press the  key to open the measurement speed selection screen.**  
Each time the  key is pressed, the screen will switch in the order PROBE → SYNC → ID Name input → RANGE → Measurement Speed → Number of Digits → Calibration standard → RS232C Baud Rate → PROBE.
- 3. Press the  key to display the desired measurement speed.**  
Each time the  key is pressed, the measurement speed switches in the order [AUTO] → [SLOW] → [FAST] → [AUTO].
- 4. Press the  key to confirm the selection.**

Menu selection screen

```
MENU : SELECT
PUSH SPACE KEY
```



Measurement speed selection screen

```
SELECT : M-SPD
AUTO
```



```
SELECT : M-SPD
SLOW
```



```
SELECT : M-SPD
FAST
```

Press the  key until the desired measurement speed appears.

"F" is displayed when the [FAST] was selected.

```
CH00 EXT Fd P1
[ ]
```

Measurement Preparation

\* By default (factory setting), the instrument is set so that [AUTO] will be selected automatically when the POWER switch is set to ON(I).

\* To cancel selection of measurement speed, press the  key.

### <Notes when Selecting the Measurement Speed>

- The selected measurement speed data will be kept even if the POWER switch is set to OFF(O).  
The selected measurement speed will be effective when the POWER switch is set to ON(I).





\*\*Flicker Mode is a function which can be used only when LCD Flicker Measuring Probe(CA-P12/15) or Small LCD Flicker Measuring Probe(CA-PS12/15) is connected.

## 2. Selecting SYNC Mode

In SYNC mode, measurement time (sampling time) is selected according to the display's vertical scanning frequency. The following five SYNC modes are available. Select the SYNC mode suitable for the display to be measured.

SYNC Mode	Description	Measurement time (Sampling time)	Vertical scanning frequency	Display's vertical synchronizing signal
NTSC	Used for measurement of NTSC monitors	33.3 ms	60 Hz	Not required
PAL	Used for measurement of PAL and SECAM monitors	40.0 ms	50 Hz	Not required
EXT	Used to synchronize measurement with the monitor's vertical synchronizing signal (frequency: 40 to 200 Hz) that is input to the instrument. (For how to input the vertical synchronizing signal, refer to page 28.)	(1 vertical scan cycle) × 2	40 to 200 Hz (Flicker 40 to 130 Hz)	Required
UNIV.	Used for measurement of any monitors, for instance, when the frequency of monitor's vertical synchronizing signal is unknown or when the vertical synchronizing signal cannot be input into the instrument for some reason.	100 ms	—	Not required
INT	If the frequency of the monitor's vertical synchronizing signal is known, set it to be used for measurement.	(1 vertical scan cycle) × 2	40 to 200 Hz (Flicker 40 to 130 Hz)	Not required

### [Selecting Method]

- 1. Press the  key.**  
The LCD display section will switch to the menu selection screen.
- 2. Press the  key to open the SYNC selection screen.**  
Each time the  key is pressed, the screen will switch in the order PROBE → SYNC → ID Name input → RANGE → Measurement Speed → Number of Digits → Calibration standard → RS232C baud rate → PROBE.
- 3. Press the  key to display the SYNC mode you want to select.**  
Each time the  key is pressed, SYNC mode switches in the order EXT → UNIV → INT → NTSC → PAL → EXT. "INT" allows you to change the synchronizing frequency.

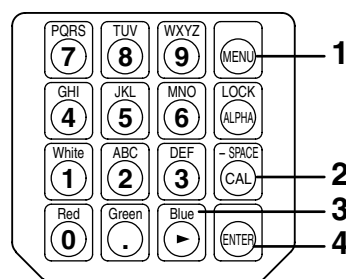

Menu selection screen

```
MENU : SELECT
PUSH SPACE KEY
```



SYNC selection screen

```
SELECT : SYNC.
EXT
```



```
SELECT : SYNC.
UNIV
```



Press the  key until the desired SYNC mode is displayed.

SYNC Mode

```
CH00 EXT Ad P1
[ ]
```



#### 4. Press the key to confirm the selection.

- \* To use EXT mode, the vertical synchronizing signal used for the display must be input to the instrument. (Page 28)
- \* By default (factory setting), the instrument is set so that EXT mode will be selected automatically when the POWER switch is set to ON. If you want to change this setting, refer to page 29.

### <Changing the Synchronizing Frequency for INT>

Select INT as explained above, and enter the desired frequency using the number-key.



### <Relationship between Measurement Speed and SYNC Mode>

The measurement time (sampling time) is determined by the selected SYNC mode. The measurement speed (the number of measurements and outputs per second) is determined by the SYNC mode and the following conditions.

- Luminance of the display to be measured
- Measurement mode
- Data output (RS-232C or USB)
- In case RS-232C, Baud rate
- Number of measuring probes to be used (when the optional 4-Probe Expansion Board is used)

The table below shows the measurement speed for each SYNC mode when measurement is performed under the following conditions.

#### RS232C

- Luminance of the display to be measured .... No errors and warnings, and the luminance is stable.
- Display mode ..... xyLv or Flicker\*\*
- Baud rate ..... 38,400 bps
- Number of connected measuring probes ..... 1

	xyLv		Flicker
	FAST	SLOW	—
NTSC	17 measurements/sec.	4.5 measurements/sec.	16 measurements/sec.
PAL	15 measurements/sec.	4 measurements/sec.	14 measurements/sec.
EXT*	17 measurements/sec.	4.5 measurements/sec.	16 measurements/sec.
UNIV.	7 measurements/sec.	1.5 measurements/sec.	—
INT*	17 measurements/sec.	4.5 measurements/sec.	16 measurements/sec.

\* The measurement speed for EXT and INT when the vertical scanning frequency is 60 Hz is given.

#### USB

- Luminance of the display to be measured .... No errors and warnings, and the luminance is stable.
- Display mode ..... xyLv or Flicker\*\*
- Number of connected measuring probes ..... 1

	xyLv		Flicker
	FAST	SLOW	—
NTSC	20 measurements/sec.	5 measurements/sec.	16 measurements/sec.
PAL	17 measurements/sec.	4 measurements/sec.	14 measurements/sec.
EXT*	20 measurements/sec.	5 measurements/sec.	16 measurements/sec.
UNIV.	8 measurements/sec.	1.5 measurements/sec.	—
INT*	20 measurements/sec.	5 measurements/sec.	16 measurements/sec.

\* The measurement speed for EXT and INT when the vertical scanning frequency is 60 Hz is given.

\*\*Flicker Mode is a function which can be used only when LCD Flicker Measuring Probe(CA-P12/15) or Small LCD Flicker Measuring Probe(CA-PS12/15) is connected.

**<Error Messages in LCD Display Section>** ... For other error messages, refer to page 101.

● “NO SYNC. SIGNAL” (when EXT mode is selected)

- Cause① : The vertical synchronizing signal used for the display is not connected to the terminal on the instrument.  
Action : If EXT mode is selected, input the vertical synchronizing signal to the terminal on the instrument properly.
- Cause② : The frequency of the vertical synchronizing signal used for the display is below 40 Hz or beyond 200 Hz.  
Action : Change SYNC mode to UNIV. mode and start measurement.

### 3. Selecting the Measurement Mode

The following measurement modes are available.

Measurement Mode		Description
xyLv mode		Used to display/output chromaticity coordinates xy and luminance Lv. (The analog display section shows $\Delta x$ , $\Delta y$ and $\Delta Lv$ .)
T $\Delta uv$ Lv mode		Used to display/output T (correlated color temperature), $\Delta uv$ (color difference from blackbody locus) and luminance Lv. (The analog display section shows $\Delta x$ , $\Delta y$ and $\Delta Lv$ .)
Analyzer mode	G Standard	Used to display measurement RGB emission intensities as a percentage of the RGB emission intensities target color(W). Analog display shows measured ratios R/G and B/G, and $\Delta G$
	R Standard	Used to display measurement RGB emission intensities as a percentage of the RGB emission intensities target color(W). Analog display shows measured ratios G/R and B/R, and $\Delta R$
u'v'Lv mode		Used to display/output u'v' chromaticity coordinates (CIE 1976 UCS chromaticity diagram) and luminance Lv. (The analog display section shows $\Delta x$ , $\Delta y$ and $\Delta Lv$ .)
Flicker mode		Used to display flicker amount obtained from contrast format (AC/DC). The unit is %. Can be selected only when LCD Flicker Measuring Probe(CA-P12/15) or Small LCD Flicker Measuring Probe(CA-PS12/15) is connected. <b>When the optional 4-Probe Expansion Board CA-B14 is used</b> Can be selected only when LCD Flicker Measuring Probe(CA-P12/15) or Small LCD Flicker Measuring Probe(CA-PS12/15) is selected.
XYZ mode		Used to display/output tristimulus values X, Y and Z. (The analog display section shows $\Delta x$ , $\Delta y$ and $\Delta Lv$ .)

## [Selecting Method]

Press the **MODE** key to display the measurement mode you want to select.

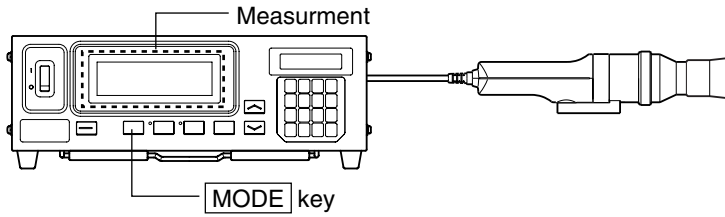

Each time the **MODE** key is pressed, measurement mode will switch as shown below.

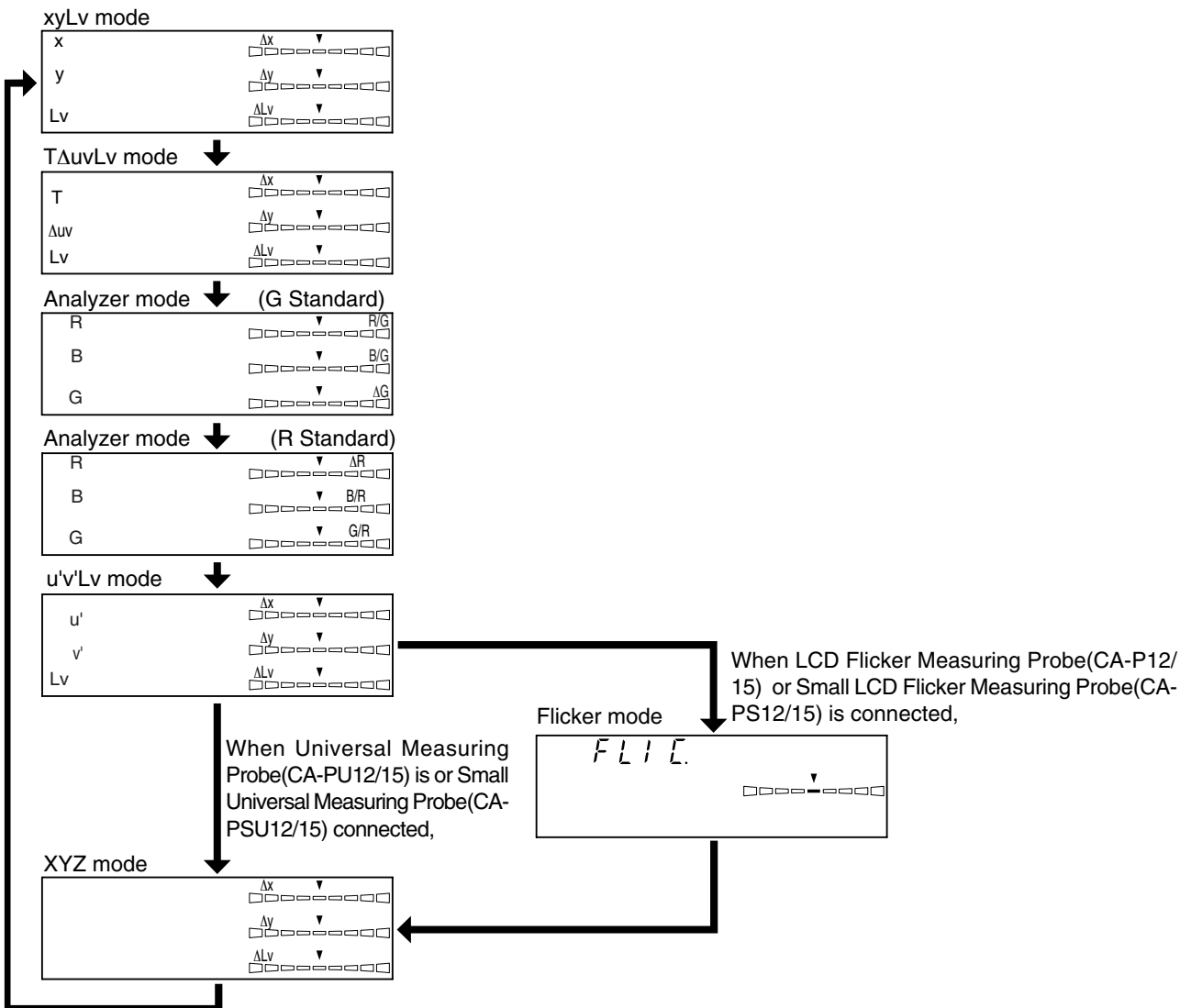

\* By default (factory setting), the instrument is set so that xyLv mode will be selected automatically when the POWER switch is set to ON (1).

## 4. Selecting the Number of Display Digits

The number of display digits can be selected from 4 or 3.

However, T(correlated color temperature) is always displayed in three digits, and flicker is always displayed up to the first decimal place.

### [Selecting Method]

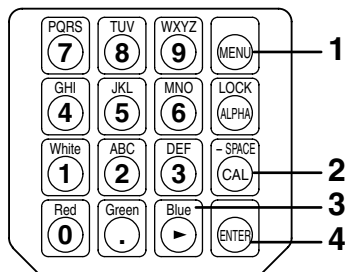

#### 1. Press the key.

The LCD display will switch to the menu selection screen.

#### 2. Press the key to open the number of display digits selection screen.

Each time the key is pressed, the screen will switch in the order PROBE → SYNC → ID Name input → RANGE → Measurement Speed → Number of Digits → Calibration standard → RS232C Baud Rate → PROBE.

#### 3. Press the key until the desired number of display digits appears.

Each time the key is pressed, the number of display digits switches alternately between “4 FIGURES” and “3 FIGURES”.

#### 4. Press the key to confirm the selection.

\* By default (factory setting), the instrument is set so that “4 FIGURES” will be selected automatically when the POWER switch is set to ON( I ).

\* To cancel selection of the number of display digits, press key.

Menu selection screen

```
MENU : SELECT
PUSH SPACE KEY
```

Number of display digits selection screen

```
SELECT : DISP.
4 FIGURES
```

```
SELECT : DISP.
3 FIGURES
```

Press the key until the desired number of display digits appears.

### <Notes on Number of Display Digits Setting>

- The selected number of display digits will be kept even if the POWER switch is set to OFF(O).  
The selected number of display digits will be effective when the POWER switch is set to ON( I ).

# Selecting Probe No.

Measurement will be performed simultaneously with all the connected measuring probes. However, the digital and analog display sections show only the measurement results taken by the one selected probe.

Follow the procedure given below to select the probe connector No. (P1 to P5) to which the desired measuring probe is connected.

In this example, a measuring probe is connected to the probe connectors [P1], [P3] and [P5].

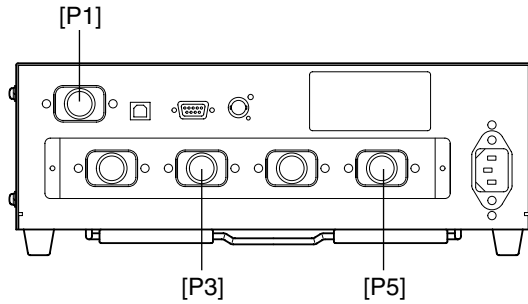

## [Selecting Method]

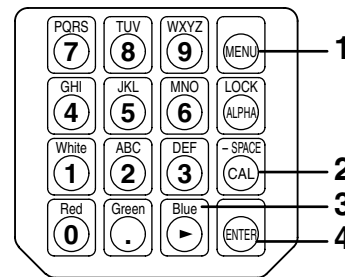

1. Press the key.

The LCD display section will switch to the menu selection screen.

2. Press the key to open the PROBE selection screen.

Each time the key is pressed, the screen will switch in the order PROBE → SYNC → ID Name input → RANGE → Measurement Speed → Number of Digits → Calibration standard → RS232C Baud Rate → PROBE.

3. Press the key to display the probe no. you want to select.

Each time the key is pressed, the probe no. switches in the order [P1]→[P3]→[P5]→[P1].

The probe type is displayed on the right of the probe serial number by the connected probe.

"U" : Universal Measuring Probe(CA-PU12/15)

"u" : Small Universal Measuring Probe(CA-PSU12/15)

Nothing : LCD Flicker Measuring Probe(CA-P12/15)

"S" : Small LCD Flicker Measuring Probe(CA-PS12/15)

\* When the measurement mode is Flicker Mode, Universal Measuring Probe(CA-PU12/15) or Small Universal Measuring Probe(CA-PSU12/15) is not displayed.

Select the measurement mode other than Flicker Mode, if you want to select Universal Measuring Probe(CA-PU12/15) or Small Universal Measuring Probe(CA-PSU12/15).

4. Press the key to confirm the selection.

\* By default (factory setting), the instrument is set so that [P1] will be selected automatically when the POWER switch is set to ON( I ).

Menu selection screen  
MENU : SELECT  
PUSH SPACE KEY

PROBE selection screen  
SELECT : PROBE  
P1 35881112 U

SELECT : PROBE  
P3 35881113

SELECT : PROBE  
P5 35881114

Press the key until the desired probe no. appears.

CH00 EXT Ad P1U  
[ ]



# Settings Section

This section explains settings that must be made according to measurement mode.

The setting method varies with measurement mode.

## From the Measurement Preparation Section

<b>Outline of the Settings Section</b> Explains measurement method types and settings that must be made. (Find out what settings you have to make.)	Page 46
---	---------

<b>Before Making Each Setting</b> Gives detailed explanations on memory channels common to each setting and target colors.	Page 48
---	---------

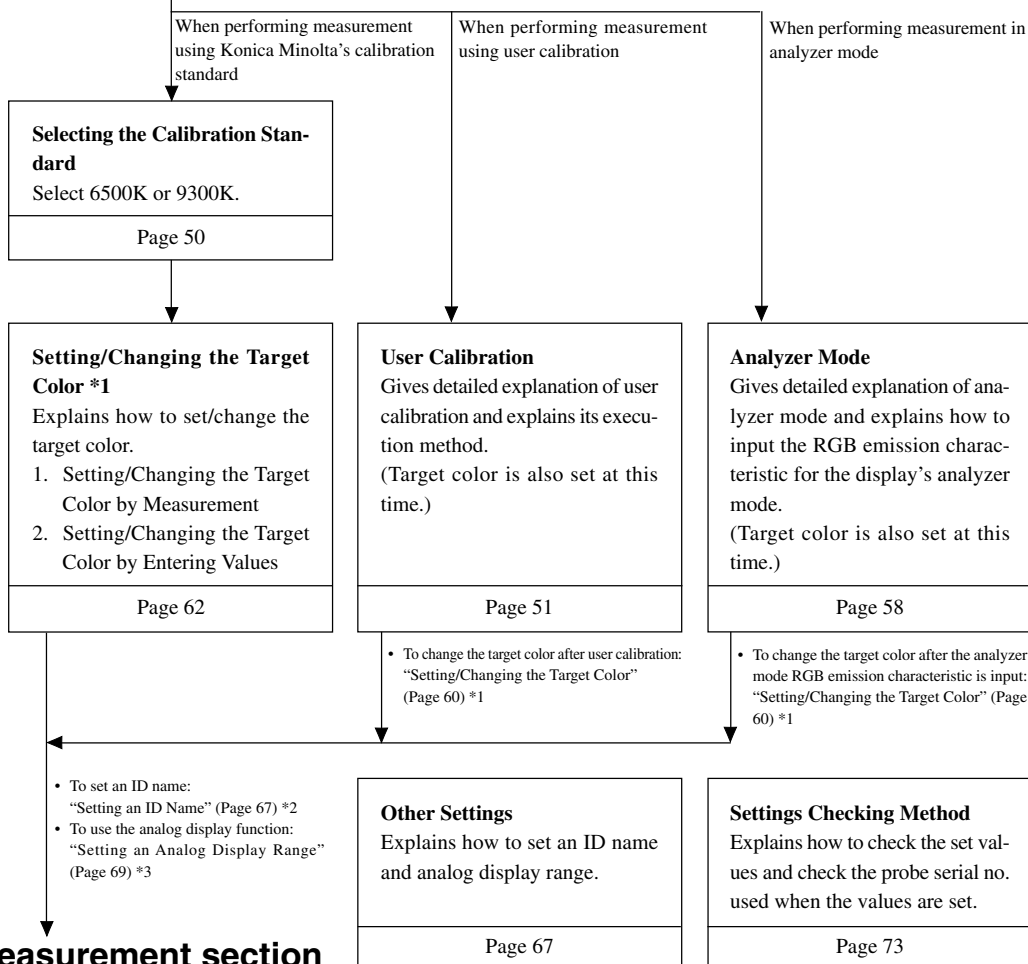

To the Measurement section

# Outline of the Settings Section+

This section explains settings that must be made according to measurement method.  
Available measurement methods and the settings that must be made are explained below.

## <Measurement by Konica Minolta’s Calibration Standard>

With this method, measurement is performed using Konica Minolta’s calibration standard without calibration. Even if you are setting the target color to the memory channel CH00, measurement must be performed as explained below.

**It is not necessary to set/change the target color if you are not going to use the analog display function.**

### [Operating Procedure]

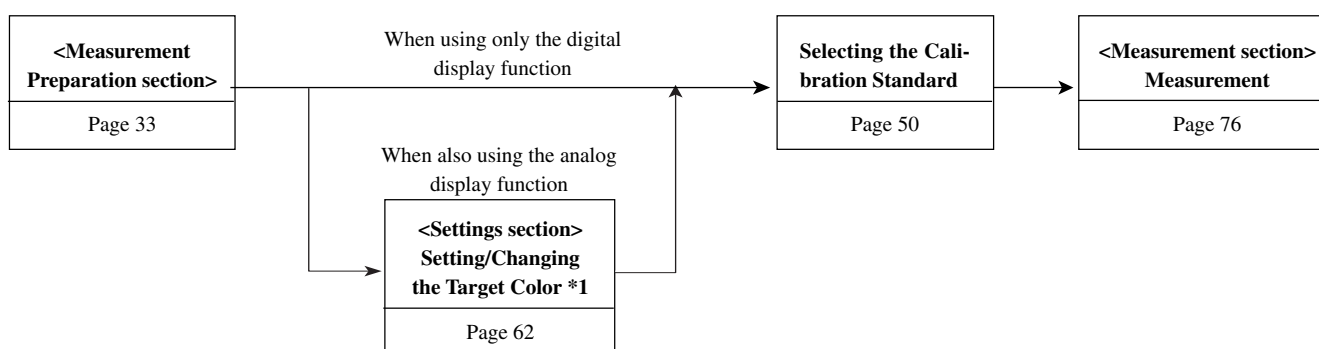

- To set an ID name : “Setting an ID Name” (Page 67) \*2
- To use the analog display function: “Setting an Analog Display Range” (Page 69) \*3

## <Measurement by User Calibration>

With this method, user calibration is performed and the obtained correction factor is used for measurement. Since the target color is also set, the analog display section can show the deviation of the measured values from the target color. User calibration must be performed in the following cases. (However, it is not possible to perform user calibration using the memory channel CH00.)

- To correct variation of readings that occur due to the deviation of spectral sensitivity from the CIE 1931 color-matching function
- To correct difference of readings between instruments when two or more instruments are used
- Correction of difference of readings between measuring probes when two or more probes are used

### [Operating Procedure]

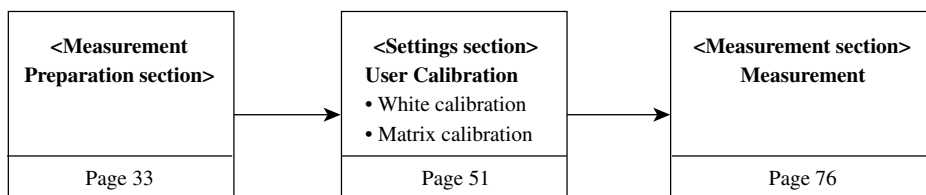

- Details of user calibration : “About User Calibration” (Page 51)
- To change the target color after user calibration: “Setting/Changing the Target Color” (Page 62) \*1
- To set an ID name : “Setting an ID Name” (Page 67) \*2
- To use the analog display function : “Setting an Analog Display Range” (Page 69) \*3



## <Measurement by Analyzer Mode>

With this method, the measured colors are expressed in emission intensity of each R, B and G monochromatic light based on the display's analyzer mode RGB emission characteristic (which is input to the instrument's memory channel) and the target color (W).

Since the target color is also set, the analog display section can show the deviation of the measured values from the target color. If this method is used when adjusting display's white balance, the adjustment can be performed more easily than xyLv mode.

### [Operating Procedure]

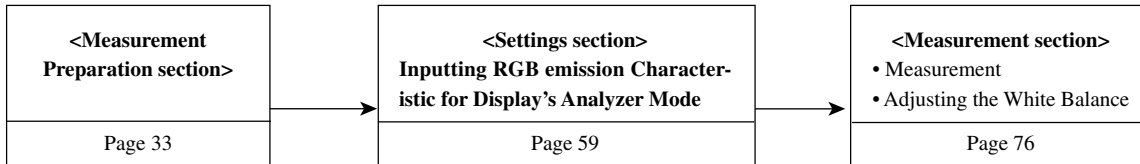

- Details of analyzer mode : “About Analyzer Mode” (Page 58)
- To change the target color after the analyzer mode RGB emission characteristic is input : “Setting/Changing the Target Color” (Page 62) \*1
- To set an ID name : “Setting an ID Name” (Page 67) \*2
- To use the analog display function : “Setting an Analog Display Range” (Page 69) \*3

#### \*1 About “Setting/Changing the Target Color”

There are the following two methods for setting/changing the target color.

- ① Setting/changing the target color by measurement ..... The display's measured values are set as the target color. This method can be used for any memory channels.
- ② Setting/changing the target color by entering values ..... Set the desired values (x, y, Lv) by entering them directly using the instrument's number-key. This method can be used for memory channel CH00 only.

#### \*2 About “Setting an ID Name”

An ID name is a name that can be assigned to each memory channel by entering it directly using keys.

This function is useful when you want to specify that user calibration and target color have been set for what type of display with what colors.

#### \*3 About “Setting an Analog Display Range”

Adjustment is performed by setting the analog display range for each dot.

\* To check the specified target color, calibration data for user calibration and probe serial no. used when these settings are made, refer to “Settings Checking Method” on page 73.

# Before Making Each Setting

## 1. About Memory Channels



This instrument has a total of 100 channels (CH00 to CH99).

The following items can be set for each of these channels.

- ① Correction factor for user calibration .....  
..... (For details, refer to page 51.)
- ② RGB emission characteristic for analyzer mode .....  
..... (For details, refer to page 59.)
- ③ Target color ..... (For details, refer to page 49.)
- ④ ID name ..... (For details, refer to page 67.)

CH00 is provided for calibration that uses Konica Minolta's calibration standard.

For this channel, only the target color, RGB emission characteristic for display's analyzer mode and ID name can be set.

The desired memory channel can be selected by switching from one to another by pressing the MEMORY CH  and  keys.

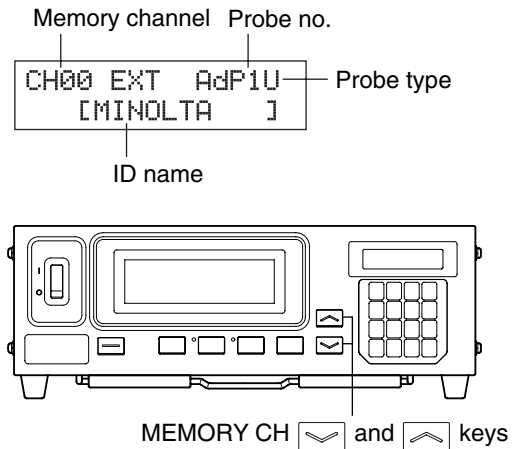

It is also possible to assign an ID name to each memory channel by entering it directly using keys. The ID name is displayed together with the memory channel no. in the LCD display section.

- If the RGB emission characteristic for analyzer mode is input using a memory channel that has been matrix-calibrated, the correction factor for matrix calibration will be deleted. (If xyLv, TΔuvLv, u'v'Lv or XYZ measurement mode is selected, the Konica Minolta's calibration standard will be used for measurement.)
- In the case of the same memory channels and probes, the RGB emission characteristic for analyzer mode is stored in their common memory irrespective of measurement mode. Therefore, when matrix calibration is performed, the RGB emission characteristic for analyzer mode is also input at the same time.

### User Calibration How the memory is used in the case of analyzer mode

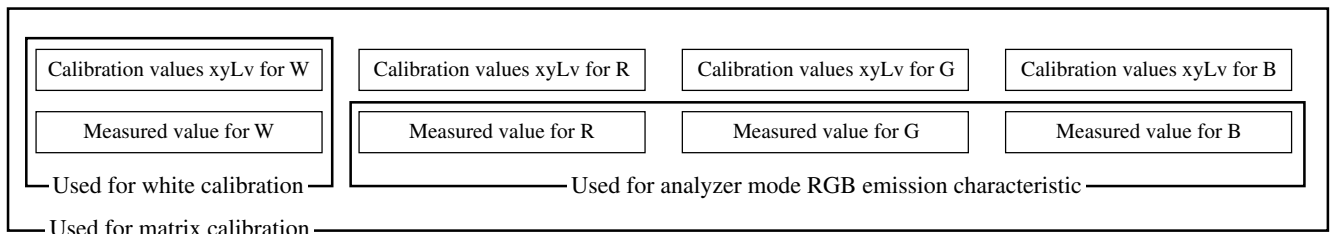

### When the optional 4-Probe Expansion Board CA-B14 is used

#### <Relationship between Memory Channels and Probes>

If the 4-Probe Expansion Board is installed, each probe ([P1] to [P5]) has a total of 100 channels (CH00 to CH99). The correction factor for user calibration (1), RGB emission characteristic for analyzer mode (2) and target color (3) can be set for each probe. However, ID name (4) is common to all the probes of the same memory channels.

For instance, if the ID name "CRT-001" is assigned to CH01 when the measured values for probe [P1] are displayed, "CRT-001" will be displayed for CH01 of all the probes [P1] to [P5].

Probe no.	[P1]	[P2]	[P3]	[P4]	[P5]
Usable memory channels	CH00 to 99	CH00 to 99	CH00 to 99	CH00 to 99	CH00 to 99
ID name (page 65)	CH00 to 99 (Common to all probes)				

## 2. About the Target Color

---

The target color is the reference used to measure how much the measured values are deviated from a certain color. The target color can be set for each probe of each memory channel.

The target color is set when the following is performed.

- ① User calibration (page 51) ..... Performing user calibration sets the calibration values as the target color.
- ② Setting/changing the target color ..... Set or change the target color in the following cases.  
(page 62)
  - When you want to set the target color for memory channel CH00
  - When you want to set a color that differs from the color used for user calibration as the target color to a user-calibrated memory channel
  - When you want to perform measurement using Konica Minolta's calibration standard without user calibration and want to use the analog display function
- ③ Inputting the RGB emission ..... When you select analyzer measurement mode and input the RGB characteristic for analyzer mode emission characteristic for analyzer mode, also set the target color (page 59) (W).

- Since when calibration factor is input for user calibration/analyzer mode the target color is also set at the same time, the previously set target color will be deleted.
- To change the currently set target color, change it as explained in “Setting/Changing the Target Color” (page 62). Even if the target color is changed, the currently set correction factor for user calibration and the RGB emission characteristic for display's analyzer mode will remain unchanged.

In the case of the same memory channels, the target color is stored in their common memory irrespective of measurement mode.

As a result, the target color set last will be stored irrespective of how it was set.

In one memory channel and one probe, a correction factor of User Calibration is common to xyLv mode, TΔuvLv mode, u'v'Lv mode and XYZ mode.

Target color is common to all measuring modes.

### 3. Selecting the Calibration Standard (data)

This section explains how to select the instrument's calibration standard (6500K, 9300K). Selecting the instrument's calibration standard will set the calibration standard for CH00 as well as for all the memory channels which have not been user-calibrated.

#### [Selecting Method]

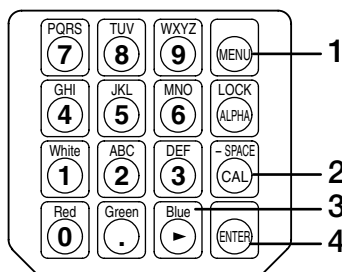

**1. Press the  key.**

The LCD display section will switch to the menu selection screen.

Menu selection screen

```
MENU : SELECT
PUSH SPACE KEY
```

**2. Press the  key to open the calibration standard selection screen.**

Each time the  key is pressed, the screen will switch in the order PROBE → SYNC → ID Name input → RANGE → Measurement Speed → Number of Digits → Calibration Standard → RS232C Baud Rate → PROBE.

SYNC selection screen

```
SELECT : STD-DT
6500K
```

The currently selected calibration standard will be displayed.

Press the  key until the desired calibration standard appears.

```
SELECT : STD-DT
9300K
```

**3. Press the  key to display the calibration standard you want to select.**

Each time the  key is pressed, the calibration standard switches alternately between "6500K" and "9300K".

**4. Press the  key to confirm the selection.**

The selected calibration standard will be set for CH00 as well as for all the memory channels that have not been user-calibrated.

\* By default (factory setting), the instrument is set so that 6500K mode will be selected automatically when the POWER switch is set to ON (I).

\* To cancel calibration standard setting, press the  key.

#### <Notes on Calibration Standard Setting>

- The specified calibration target values will be kept even if the POWER switch is set to OFF (O). The selected calibration standard will be set for CH00 as well as for all the non-user-calibrated memory channels when the POWER switch is set to ON (I).

# User Calibration

## 1. About User Calibration

- User calibration is provided to set the user's own correction factor to the instrument's memory channels by measuring the color of a display and setting the calibration values (x, y, Lv) to the instrument. Once this factor is set, the values corrected by this factor will be displayed and output each time measurement is taken.
- This instrument allows two kinds of user calibration; white calibration and matrix calibration. By default (factory setting), matrix calibration is selected.
- User calibration can be performed for each memory channel. (Except for CH00)
- **When the optional 4-Probe Expansion Board CA-B14 is used**  
User calibration is performed independently for probe ([P1] to [P5]) for each memory channel. (Except for CH00)
- When this instrument is used for the first time since shipment from the factory, measurement will be performed based on the calibration carried out by the Konica Minolta's calibration standard. This applies to all the memory channels. Once user calibration is performed, the following correction will be made when measurement is performed using the obtained correction factor.
  - ① Correction of variation of readings that occur due to the deviation of spectral sensitivity from the CIE 1931 color-matching function
  - ② Correction of difference of readings between instruments when two or more instruments are used
  - ③ **When the optional 4-Probe Expansion Board CA-B14 is used**  
Correction of difference of readings between measuring probes when two or more probes are used
- At the same time as user calibration is performed for a memory channel, the obtained color will be set as the target color to that memory channel. The target color is the color used as the reference when displaying how much the measured values are deviated from a certain color. (Page 49)
- When User Calibration is implemented, the same Measuring Probe to be used for the measurement is necessary. If measurement is carried out by connecting the different Measuring Probe, error message E1 will be displayed. In this case, it is necessary to replace it with the Measuring Probe that received User Calibration or you have to execute User Calibration once again using the Measuring Probe to be used for the measurement.

### <When Two or More Instruments are Used>

When two or more instruments are used or when the optional 4-Probe Expansion Board CA-B14 is used to perform measurement with two or more measuring probes, the difference between readings can be corrected if user calibration is performed as explained below.

#### When the values of the color to be used as the target are known:

The color set to the reference display is displayed and user calibration is performed for all the bodies (or measuring probes).

#### When the values of the color to be used as the target are unknown:

- ① Select one master body (or select one master probe).
- ② Select "xyLv" measurement mode (page 40), and place the master body's measuring probe (or the master probe) against the display on which the target color is displayed.
- ③ While the probe is placed against the display, press the **HOLD** key.
- ④ By using the display on which the target color is displayed and the values displayed at step ③, perform user calibration for the other bodies (or measuring probes).

## 2. Performing White Calibration





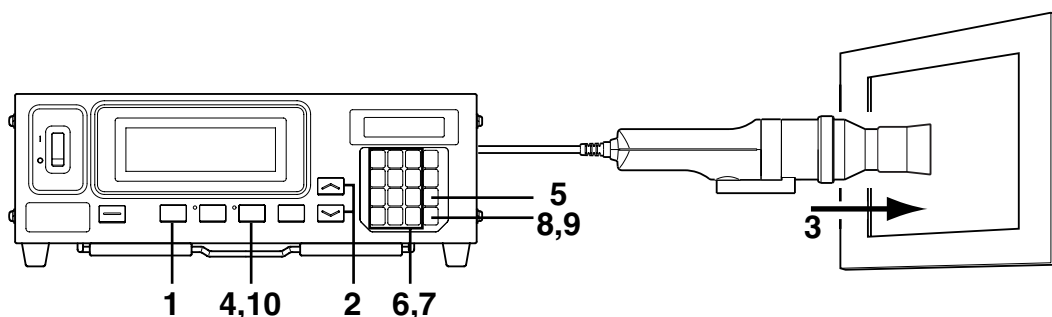

- User calibration cannot be performed with the memory channel CH00.  
(CH00 memory channel is provided for measurement that uses the Konica Minolta's calibration standard.)
- White calibration must be performed for each display type (model).  
Characters of displays vary with the display type (model). Because of this, measured values differ even if the same color is measured. Thus, a different memory channel must be used for each display type (model) to perform white calibration.
- If white calibration is performed with a memory channel to which the target color has already been set, that target color will be deleted.
- If white calibration is performed with a memory channel which has already been matrix-calibrated, the correction factor of the previous matrix calibration will be deleted and the correction factor obtained from the white calibration will be set.

### [Operating Procedure]



#### When the optional 4-Probe Expansion Board CA-B14 is used

Select the probe no. to be white-calibrated. White calibration can be performed independently for each probe connector ([P1] to [P5]) for each memory channel.

- ① **Press the  key.**  
The LCD display section will switch to the menu selection screen.
- ② **Press the  key to open the PROBE selection screen.**  
Each time the  key is pressed, the screen will switch in the order PROBE → SYNC → ID Name input → RANGE → Measurement Speed → Number of Digits → Calibration Standard → RS232C Baud Rate → PROBE.
- ③ **Press the  key to display the probe no. you want to select.**  
Each time the  key is pressed, the probe no. switches in the order [P1] ...
- ④ **Press the  key to confirm the selection.**

Menu selection screen

```
MENU : SELECT
PUSH SPACE KEY
```



PROBE selection screen

```
SELECT : PROBE
P1 35881112 U
```

```
SELECT : PROBE
P3 35881113
```

Probe no.

Press the  key until the desired probe no. appears.

\* By default (factory setting), the instrument is set so that [P1] will be selected automatically when the POWER switch is set to ON( I ).

1. Press the **MODE** key to select xyLv measurement mode.
2. Press the MEMORY CH and keys until the memory channel where you want to perform white calibration appears.

```
CH01 EXT Ad P1U
[ ]
```

3. Place the measuring probe against the display.

Make sure that the white color whose values are known is shown on the display.

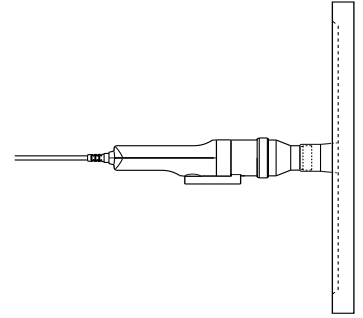

4. While the probe is placed against the display, press the **HOLD** key.

The latest measured values will be hold and the HOLD LED lights up.

5. Press the key.

The LCD display section will switch to the user calibration input screen.

```
CH01 U-CAL
P1 W R G B
```

6. Press the key.

The LCD display section will switch to the W calibration value input screen.

```
CH01 x y Lv P1
0000 0000 0.00
```

7. Enter calibration values (x, y, Lv).

For x and y, a value 10000 times the calibration value must be entered.

Use the number-key ( to , ) to enter the values.

The cursor moves to the right each time a value is entered.

Each time the key is pressed, the cursor moves in the order x → y → Lv → x.

In this example, x=0.3300, y=0.3000 and Lv=39.50 are entered.

① Press the , , and then key to enter the “x” value.

② Press the key.

The cursor ( ) will move to “y”.

③ Press the , , and then key to enter the “y” value.

④ Press the key.

The cursor ( ) will move to “Lv”.

⑤ Press the , , , and then key to enter the “Lv” value.

```
CH01 x y Lv P1
3300 0000 0.00
```

```
CH01 x y Lv P1
3300 3000 0.00
```

```
CH01 x y Lv P1
3300 3000 39.50
```

8. Press the key.

The LCD display section will return to the user calibration input screen, with the “\*” mark displayed indicating that values have been entered for “W”.

```
CH01 U-CAL
P1 *W R G B
```

“\*” mark is displayed.

9. Press the key.

White calibration will start, and the entered values will be set as the target color when the correction factor is entered.

10. Press the **HOLD** key to start measurement.

\* To cancel white calibration, press the key before pressing the key at step 9.

\* To view the white-calibrated values (target color values), press the **MR** key. However, if the target color is set after white calibration is performed with the same memory channel, the values for that target color will be displayed. (For details, refer to page 73.)

- \* If measurement is performed with non-user-calibrated memory channel for the first time since shipment from the factory, the Konica Minolta’s calibration standard will be used for the measurement.
- \* To change the target color you set, change it as explained in “1. Setting/Changing the Target Color by Measurement” (page 63). The currently set correction factor for white calibration will remain unchanged even if the target color is changed.
- \* White calibration can still be performed even if the measured values are not hold (i.e. even if the **HOLD** key is not pressed). In this case, white calibration will be performed for the measured values set by pressing the key at step 9.

Screen example after white calibration

```
x 0.3300 Ax
y 0.3000 Ay
Lv 39.50 ALV
```

Digital display section:  
Displays calibration values.

Analog display section:  
Displays the center dots only.

“a” is displayed after white calibration.

```
CH01 EXT Ad P1
[ ]
```

LCD display section:  
Memory channel  
Measurement speed  
Calibration mode  
Probe no.  
ID name

### 3. Performing Matrix Calibration





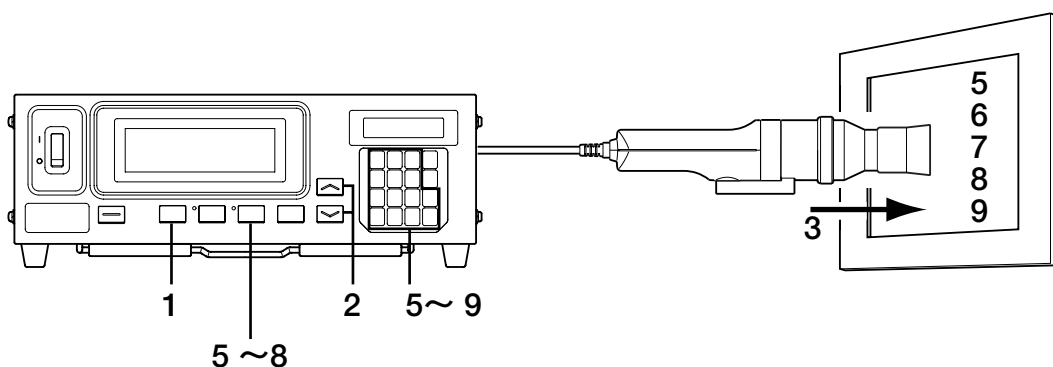

- Matrix calibration cannot be performed with the memory channel CH00.  
(CH00 memory channel is provided for measurement that uses the Konica Minolta's calibration standard.)
- Matrix calibration must be performed for each display type (model).  
Characters of displays vary with the display type (model). Because of this, measured values differ even if the same color is measured. Thus, a different memory channel must be used for each display type (model) to perform matrix calibration.
- If matrix calibration is performed with a memory channel to which the target color has already been set, that target color will be deleted.
- If matrix calibration is performed with a memory channel which has already been white-calibrated, the correction factor of the previous white calibration will be deleted and the correction factor obtained from the matrix calibration will be set.
- If matrix calibration is performed with a memory channel for which the RGB emission characteristic for the analyzer mode is to be set, the previous RGB emission characteristic will be deleted and the WRGB set for matrix calibration will be set as the RGB emission characteristic.

#### [Operating Procedure]



#### When the optional 4-Probe Expansion Board CA-B14 is used

Select the probe no. to be white-calibrated. White calibration can be performed independently for each probe connector ([P1] to [P5]) for each memory channel.

- ① **Press the  key.**  
The LCD display section will switch to the menu selection screen.
- ② **Press the  key to open the PROBE selection screen.**  
Each time the  key is pressed, the screen will switch in the order PROBE → SYNC → ID Name input → RANGE → Measurement Speed → Number of Digits → Calibration Standard → RS232C Baud Rate → PROBE.
- ③ **Press the  key to display the probe no. you want to select.**  
Each time the  key is pressed, the probe no. switches in the order [P1] ...
- ④ **Press the  key to confirm the selection.**

Menu selection screen

```
MENU : SELECT
PUSH SPACE KEY
```



PROBE selection screen

```
SELECT : PROBE
P1 35881112 U
```

```
SELECT : PROBE
P3 35881113
```

Probe no.

Press the  key until the desired probe no. appears.

\* By default (factory setting), the instrument is set so that [P1] will be selected automatically when the POWER switch is set to ON(1).



## [Preparation]

1. Press the **MODE** key to select xyLv measurement mode.

2. Press the MEMORY CH  and  keys until the memory channel where you want to perform user calibration appears.

A memory channel other than CH00 must be selected.

3. Place the measuring probe against the display and take measurement.

Set the display so that it can display four colors (RGBW) whose xyLv values are known.

4. Press the  key.

The LCD display section will switch to the user calibration input screen.

5. Enter the emission characteristic of R and calibration values (x, y, Lv).

① Place the measuring probe against the display, which is now emitting monochrome light of R.

Currently measured values will be displayed.

② While the probe is placed against the display, press the **HOLD** key.

The measured values will be hold and the HOLD LED lights up.

③ Press the  key.

The LCD display section will switch to the R calibration value input screen.

④ Enter calibration values (x, y, Lv).

Enter them in the same way as when you enter W calibration values for white calibration (see step 7 in “Performing White Calibration” on page 52).

⑤ Press the  key.

The LCD display section will return to the user calibration input screen, with the “\*” mark displayed on the left of “R”.

⑥ Press the **HOLD** key to resume measurement.

6. Enter the emission characteristic of G and calibration values (x, y, Lv).

① Place the measuring probe against the display, which is now emitting monochrome light of G.

Currently measured values will be displayed.

② While the probe is placed against the display, press the **HOLD** key.

The measured values will be hold and the HOLD LED lights up.

③ Press  key.

The LCD display section will switch to the G calibration value input screen.

④ Enter calibration values (x, y, Lv).

Enter them in the same way as when you enter W calibration values for white calibration (see step 7 in “Performing White Calibration” on page 53).

⑤ Press the  key.

The LCD display section will return to the user calibration input screen, with the “\*” mark displayed on the left of “G”.

⑥ Press the **HOLD** key to resume measurement.

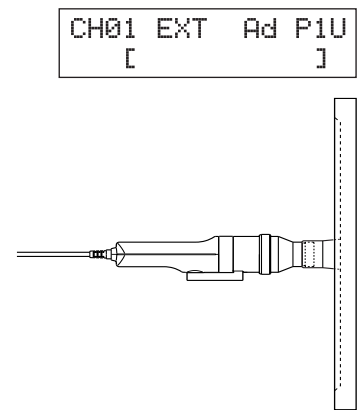

```
CH01          U-CAL
P1 W R G B
```

```
CH01 x y Lv P1
0000 0000 0.00
```

```
CH01          U-CAL
P1 W *R G B
```

“\*” mark is displayed.

```
CH01          U-CAL
P1 W *R G B
```

```
CH01 x y Lv P1
0000 0000 0.00
```

```
CH01          U-CAL
P1 W *R *G B
```

“\*” mark is displayed.

## 7. Enter the emission characteristic of B and calibration values (x, y, Lv).

① Place the measuring probe against the display, which is now emitting monochrome light of B. Currently measured values will be displayed.

② While the probe is placed against the display, press the **[HOLD]** key. The measured values will be hold and the HOLD LED lights up.

③ Press the **[Blue]** key.

The LCD display section will switch to the B calibration value input screen.

④ Enter calibration values (x, y, Lv).

Enter them in the same way as when you enter W calibration values for white calibration (see step 7 in “Performing White Calibration” on page 53).

⑤ Press the **[ENTER]** key.

The LCD display section will return to the user calibration input screen, with the “\*” mark displayed on the left of “B”.

⑥ Press the **[HOLD]** key to resume measurement.

```
CH01      U-CAL
P1 W *R *G B
```

```
CH01 x y Lv P1
 0000 0000 0.00
```

```
CH01      U-CAL
P1 W *R *G *B
```

“\*” mark is displayed.

## 8. Enter the emission characteristic of white light and calibration values (x, y, Lv).

① Place the measuring probe against the display, which is now emitting white light. Currently measured values will be displayed.

② While the probe is placed against the display, press the **[HOLD]** key. The measured values will be hold and the HOLD LED lights up.

③ Press the **[White]** key.

The LCD display section will switch to the W calibration value input screen.

④ Enter calibration values (x, y, Lv).

Enter them in the same way as when you enter W calibration values for white calibration (see step 7 in “Performing White Calibration” on page 53).

⑤ Press the **[ENTER]** key.

The LCD display section will return to the user calibration input screen, with the “\*” mark displayed on the left of “W”.

⑥ Press the **[HOLD]** key to resume measurement.

```
CH01      U-CAL
P1 W *R *G *B
```

```
CH01 x y Lv P1
 0000 0000 0.00
```

```
CH01      U-CAL
P1 *W *R *G *B
```

“\*” mark is displayed.

## 9. Press the **[ENTER]** key.

Matrix calibration will start, and the W measured values entered at step 8 will be set as the target color when the correction factor is entered.

Example of screen after matrix calibration

```
x  0.3300  Δx  ▾
y  0.3000  Δy  ▾
Lv 39.50  ΔLv ▾
```

Digital display section:  
Displays calibration values.

Analog display section:  
Displays the center dots only.

“m” is displayed after matrix calibration.

```
CH01 EXT Am P1
[      ]
```

LCD display section:  
Memory channel  
Measurement speed  
Calibration mode  
Probe no.  
ID name

\* Steps 5 to 8 can be performed in any order.

\* Pressing the **[Blue]**, **[Green]**, **[Red]** or **[White]** key before pressing the **[ENTER]** key at step 9 allows you to re-enter the emission characteristic of the color or the measured values of white light and calibration values.

\* To cancel matrix calibration, press the **[ESC]** key before pressing the **[ENTER]** key at step 9.

\* To view the target color values set for matrix calibration, press the **[MR]** key. However, if the target color is set after matrix calibration is performed with the same memory channel, the values for that target color set last will be displayed. (For details, refer to page 73.)







\* If measurement is performed with non-user-calibrated memory channel for the first time since shipment from the factory, the Konica Minolta’s calibration standard will be used for the measurement.

\* To change the target color you set, change it as explained in “1. Setting/Changing the Target Color by Measurement” (page 63). The currently set correction factor for matrix calibration will remain unchanged even if the target color is changed.

\* Matrix calibration can still be performed even if the measured values are not hold (i.e. even if the **[HOLD]** key is not pressed).

In this case, the measured values confirmed by pressing the **[ENTER]** key at steps 5 to 8 will be used for calculation of the correction factor for matrix calibration.

## <Notes on User Calibration>

- The target color is also set when user calibration is performed.  
Note that the target color is common to all measurement modes (xyLv, TΔuvLv, analyzer, u'v'Lv, XYZ).
- If the intensity of the display to be measured is 1.0 cd/m<sup>2</sup> or less (3.0 cd/m<sup>2</sup> or less when a Small Universal Measuring Probe(CA-PSU12/15) or Small LCD Flicker Measuring Probe(CA-PS12/15) is connected.) or if the ambient temperature has changed, zero calibration must be performed before user calibration.
- Static electricity on the display's screen surface must be removed as much as possible.
- Make sure that the measuring probe is placed straight against the display. If it is tilted or moved, user calibration will not be accurate.
- Take care not to let the measuring probe be exposed to excessive impact. Neither should the cord be pulled or bent excessively nor excessive force be exerted on it. Failure to observe these cautions may result in breakdown or wire-breakage.
- The  key may not be operable if "OVER" is displayed on the LCD display section.
- Never press the following keys during user calibration. Doing so will cancel user calibration and activate the mode corresponding to the pressed key.  
( , , , MEMORY CH , ,  )

## <Calibration Mode and LCD>

The following alphabet will appear at the "\*" position on the LCD display section according to the selected calibration mode.

d : Matrix calibration with Konica Minolta's calibration standard 6500K







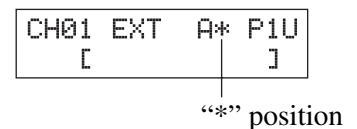

h : Matrix calibration with Konica Minolta's calibration standard 9300K

a : White calibration (user calibration)

m : Matrix calibration (user calibration)



## <Error Messages in LCD Display Section> ... For other error messages, refer to page 103.

- "E3" (When the  key is pressed in the calibration value input screen)
  - Cause : Incorrect calibration values are set. Incorrect calibration values mean the following.
    - ① One of x, y and Lv is "0".
    - ②  $1-x-y \leq 0$
    - ③ Values which are beyond the instrument's calculation capability or contradicting values
  - Action : Enter correct values and then press the  key.
- "E5" (When the  key is pressed in the calibration value input screen)
  - Cause ①: Calibration values (x, y, Lv) for white color have not been entered.  
Action : Enter the calibration values (x, y, Lv) for white color and then press the  key.
  - Cause ②: Calibration values for only some of R, G and B have been entered.  
Action : If you are going to perform white calibration, enter the values for W only.  
(Restart from step 4, where you were asked to press the  key.)  
If you are going to perform matrix calibration, enter values for the colors whose values have not been entered, and then press the  key.
- "E6" (When the  key is pressed in the calibration value input screen)
  - Cause : Incorrect calibration values are set. Incorrect calibration values mean the following.  
"E6" will appear if the calculation results obtained when calculation for matrix calibration is performed are inappropriate.
  - Action : Enter correct values and then press the  key.

# Analyzer Mode

## 1. About Analyzer Mode

### <What is Analyzer Mode?>

Analyzer measurement mode is provided for adjustment of the display's white balance.

The measured colors are expressed in output of each R, B and G monochromatic light based on the display's analyzer mode RGB emission characteristic (input to the instrument) and the target color (W).

Thus, adjusting the emission intensity of R causes the measured value of R only to change, and measured values for B and G remain unchanged. This mode is useful when you adjust the emission intensity of R, B and G to match the target color (W).

The following measured values will be displayed when the display's emission intensity (emission intensity of R, B and G monochrome lights) and the target color (W) are set and measurement is performed in analyzer mode.

- Digital display section ..... R, B, G : Outputs of the currently measured monochrome lights R, B and G in ratio (%) to those of the specified target color (W)
- Analog display section ..... When analyzer mode (G-reference) is selected  
R/G, B/G : Ratio of measured values  
 $\Delta G$  : Difference from the target color in the case of monochrome light G  
When analyzer mode (R-reference) is selected  
 $\Delta R$  : Difference from the target color in the case of monochrome light R  
G/R, B/R : Ratio of measured values

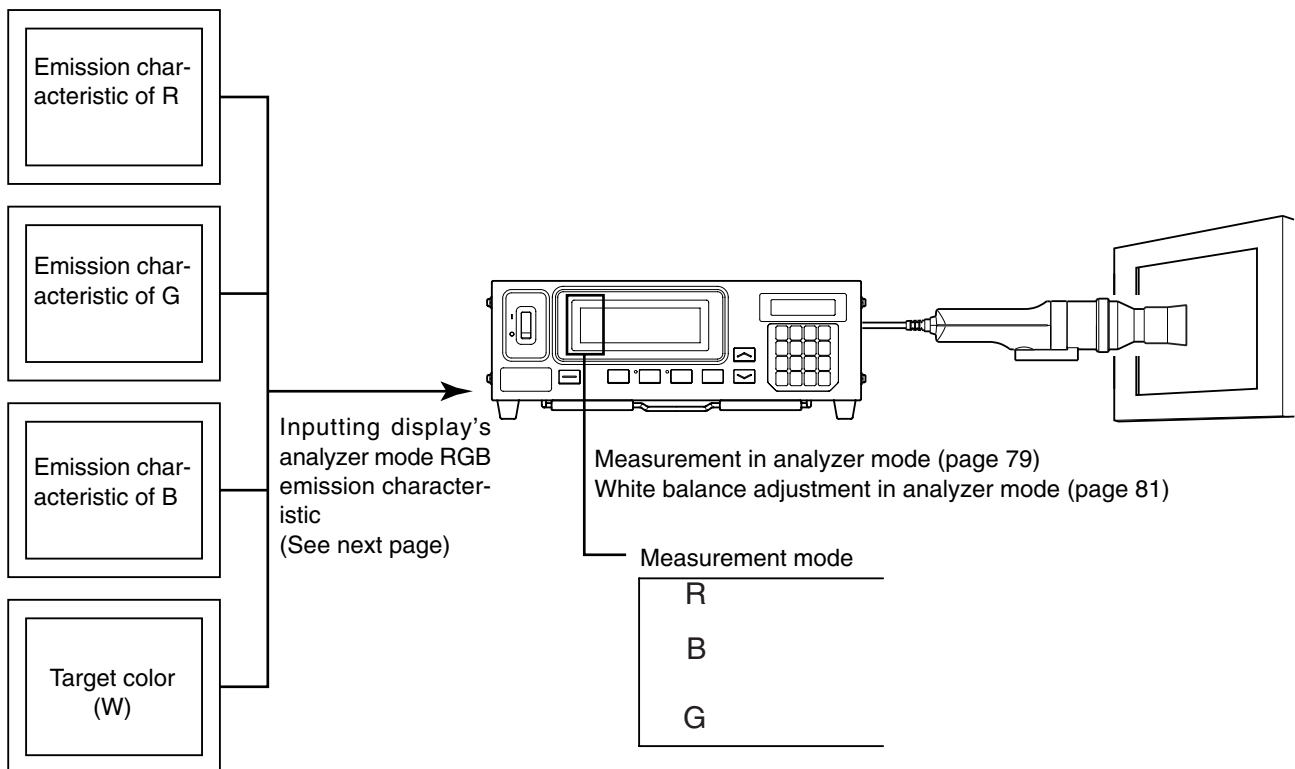

## 2. Inputting the RGB Emission Characteristic for Analyzer Mode

The RGB emission characteristic for analyzer mode must be input to each memory channel. When it is input, the target color (W) must also be set.

To adjust white balance, the values of the white-balanced white must be entered as the target color (W).

If the RGB emission characteristic for the display's analyzer mode is input to a memory channel for which the target color has already been set, the previously set target color will be deleted. The target color to be used is the same as that for xyLv, TΔuvLv, u'v'Lv and XYZ measurement modes.

The RGB emission characteristic for the display must be input for each display type (model).

Characters of displays vary with the display type (model). Because of this, measured values differ even if the same color is measured.





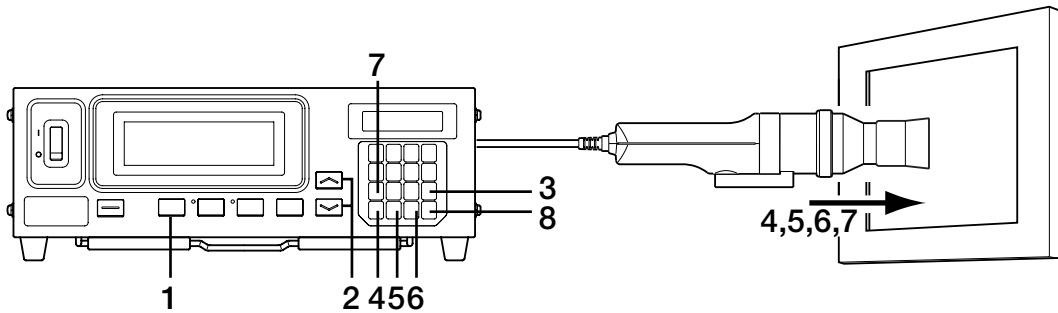

Thus, a different memory channel must be used for each display type (model) to input the RGB emission characteristic for analyzer mode.

### [Operating Procedure]



#### When the optional 4-Probe Expansion Board CA-B14 is used

Select the probe no. for which the RGB emission characteristic for the display is to be input. The RGB emission characteristic for the display can be input independently for each probe connector ([P1] to [P5]) for each memory channel.

- ① **Press the  key.**  
The LCD display section will switch to the menu selection screen.
- ② **Press the  key to open the PROBE selection screen.**  
Each time the  key is pressed, the screen will switch in the order PROBE → SYNC → ID Name input → RANGE → Measurement Speed → Number of Digits → Calibration Standard → RS232C Baud Rate → PROBE.
- ③ **Press the  key to display the probe no. you want to select.**  
Each time the  key is pressed, the probe no. switches in the order [P1] ...
- ④ **Press the  key to confirm the selection.**

Menu selection screen

```
MENU : SELECT
PUSH SPACE KEY
```



PROBE selection screen

```
SELECT : PROBE
P1 35881112 U
```



```
SELECT : PROBE
P3 35881113
```

Probe no.

Press the  key until the desired probe no. appears.

\* By default (factory setting), the instrument is set so that [P1] will be selected automatically when the POWER switch is set to ON(I).

1. Press the **MODE** key to select analyzer measurement mode (RGB).

2. Press the **MEMORY CH**  and  keys until the memory channel where you want to input the RGB emission characteristic appears.

3. Press the  key.

The LCD display section will switch to the analyzer mode RGB emission characteristic input screen.

4. Input the emission characteristic of R.

- ① Press the measuring probe against the display, which is now emitting monochrome light of R.
- ② Press the  key. In the LCD display section, the “\*” mark will appear on the left of “R”.

5. Input the emission characteristic of G.

- ① Place the measuring probe against the display, which is now emitting monochrome light of G.
- ② Press the  key. In the LCD display section, the “\*” mark will appear on the left of “G”.

6. Input the emission characteristic of B.

- ① Place the measuring probe against the display, which is now emitting monochrome light of B.
- ② Press the  key. In the LCD display section, the “\*” mark will appear on the left of “B”.

7. Enter the target color (W)



- ① Place the measuring probe against the display, which is now emitting the target color(W).
- ② Press the  key. In the LCD display section, the “\*” mark will appear on the left of “W”.

8. Press the  key.

The RGB emission characteristic for the display’s analyzer mode and target color (W) will be set.

\* Steps 4 to 7 can be performed in any order.

\* Pressing the , ,  or  key before pressing the  key allows you to re-enter the emission characteristic.

\* To cancel emission characteristic setting, press the  key before pressing the  key.

\* To change the target color you set, change it as explained in “1. Setting/Changing the Target Color by Measurement” (page 63).

Even if the target color is changed, the currently set RGB emission characteristic for display’s analyzer mode will remain unchanged.

\* Pressing the **MR** key displays “100.0” as the target color value for R, B and G.

Memory channel

```
CH01 EXT Ad P1U
 [ ]
```

```
CH01 ALZ
P1 W R G B
```

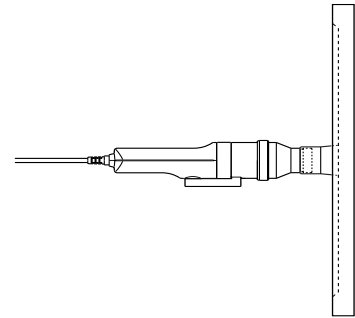

```
CH01 ALZ
P1 W *R G B
```

```
CH01 ALZ
P1 W *R *G B
```

```
CH01 ALZ
P1 W *R *G *B
```

```
CH01 ALZ
P1 *W *R *G *B
```

## <Error Messages in LCD Display Section> ... For other error messages, refer to page 103.

### ● “E1”

- Cause①: The display’s RGB emission characteristic has never been input for the currently selected memory channel since shipment from the factory.

Action : This error will disappear if you enter the emission characteristic.

- Cause②: The currently used measuring probe is different from the one that was used to input the display’s RGB emission characteristic and target color (W).

Action : Connect the same probe as the one used to input the display’s RGB emission characteristic and target color (W).

```
CH01 EXT Ad P1
E1 [ ]
```

Alternatively, input the display's RGB emission characteristic with the currently used measuring probe.

- “E5” (after the  key is pressed)

- Cause ① : The emission characteristic for one of W, R, G and B has not been input.

- Action : Input the emission characteristic for the color for which the emission characteristic has not been input, and then press the  key.

- Cause ② : The  key was pressed when the measuring range for target color (W) was exceeded.

- Action : Input the target color values (W) that are within the measuring range, and press the  key.

CH01	ALZ
E5 *W *R G *B	

## <Notes on When Inputting the RGB Emission Characteristic for Analyzer Mode>

- By default (factory setting), the RGB emission characteristic for the display's analyzer mode has not been input.

Thus, before performing measurement in analyzer mode, the RGB emission characteristic must be input.

- The target color is also set when the RGB emission characteristic is input.

Note that the target color is common to all measurement modes (xyLv, TΔuvLv, analyzer, u'v'Lv, XYZ).

- If the intensity of the display to be measured is 1.0 cd/m<sup>2</sup> or less (3.0 cd/m<sup>2</sup> or less when a Small Universal Measuring Probe(CA-PSU12/15) or Small LCD Flicker Measuring Probe(CA-PS12/15) is connected.) or if the ambient temperature has changed, zero calibration must be performed before inputting the RGB emission characteristic.

- Static electricity on the display's screen surface must be removed as much as possible.

- Make sure that the measuring probe is placed against the display. If it is tilted or moved, it is not possible to input accurate emission characteristic.

- Take care not to let the measuring probe be exposed to excessive impact. In addition, do not pull or bend the cord excessively or exert excessive force on it. Failure to observe this may result in breakdown or wire-breakage.

-  keys may not be operable if “OVER” is displayed on the LCD display section.

- Never press the following keys during setting.

Doing so will cancel setting of the emission characteristic and activate the mode corresponding to the pressed key.

( , , , MEMORY CH , ,  )

- If the RGB emission characteristic for analyzer mode is input using a memory channel that has been matrix-calibrated, the correction factor for matrix calibration will be deleted. (Konica Minolta's calibration standard will be used for measurement if xyLv, TΔuvLv, u'v'Lv or XYZ measurement mode is selected.)

- In the case of the same memory channels and probes, the RGB emission characteristic for analyzer mode is stored in their common memory irrespective of measurement mode. Therefore, when matrix calibration is performed, the RGB emission characteristic for analyzer mode is also input at the same time.

### User Calibration How the memory is used in the case of analyzer mode

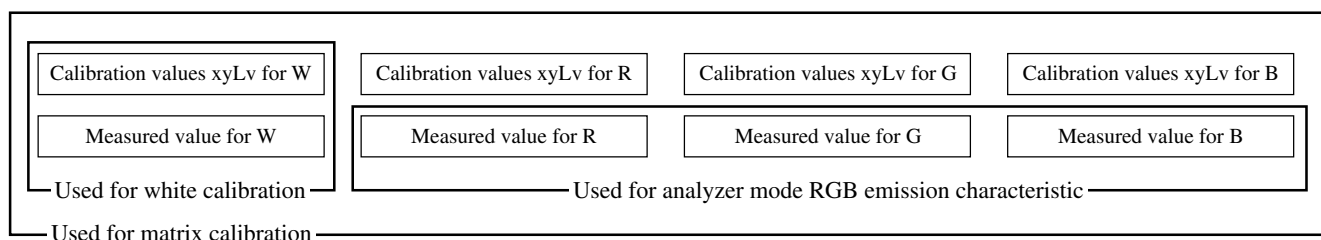

---

# Setting/Changing the Target Color

---

## If you have input the RGB emission characteristic for user calibration/analyzer mode:

It is not necessary to set the target color in the following cases.

- ① When you want to set the user-calibrated color as the target color for a memory channel
- ② When you want to set the target color (W) which was set when the RGB emission characteristic for the display's analyzer mode was set as the target color

The target color set here is the same as those set by ① and ② Only when you want to change the currently set target color, should it be changed it as explained below.

By setting the target color, the difference between the measured value and the target color can be displayed in the analog display section. The target color can be set for each probe of each memory channel.

The target color must be set in the following cases.

- When you want to set the target color for memory channel CH00
- When you want to perform measurement using Konica Minolta's calibration standard without user calibration and want to use the analog display function
- When you want to set a color that differs from the color used for user calibration as the target color to a user-calibrated memory channel
- **When the optional 4-Probe Expansion Board CA-B14 is used**  
When you want to set the target color (W) that has already been set and another color as the target color to a memory channel for which the RGB emission characteristic for analyzer mode has been input

There are the following two methods of setting/changing the target color. Some memory channels do not allow you to set the target color.

1. Setting/changing the target ..... The display's measured value is set as the target color.  
color by measurement This method can be used for any memory channels.
2. Setting/changing the target color ..... Set the desired values (x, y, Lv) by entering them directly using the  
by entering values instrument's number-key. This method can be used for memory channel CH00 only. (This method is not possible if analyzer measurement mode is selected.)



# 1. Setting/Changing the Target Color by Measurement

## [Operating Procedure]

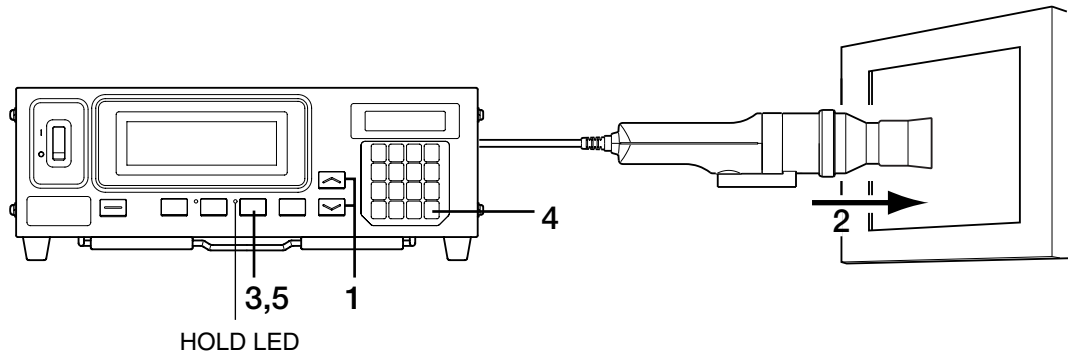

When the optional 4-Probe Expansion Board CA-B14 is used

Select the probe no. to which you want to set the target color. The target color can be set independently for each probe connector ([P1] to [P5]) for each memory channel.

- ① **Press the key.**  
The LCD display section will switch to the menu selection screen.
- ② **Press the key to open the PROBE selection screen.**  
Each time the key is pressed, the screen will switch in the order PROBE → SYNC → ID Name input → RANGE → Measurement Speed → Number of Digits → Calibration Standard → RS232C Baud Rate → PROBE.
- ③ **Press the key to display the probe no. you want to select.**  
Each time the key is pressed, the probe no. switches in the order [P1] ...
- ④ **Press the key to confirm the selection.**

Menu selection screen

```
MENU : SELECT
PUSH SPACE KEY
```

PROBE selection screen

```
SELECT : PROBE
P1 35881112 U
```

```
SELECT : PROBE
P3 35881113
```

Probe no.

Press the key until the desired probe no. appears.

1. **Press the MEMORY CH and keys until the memory channel where you want to set the target color appears.**
2. **Place the measuring probe against the display and take measurement.**
3. **While the probe is placed against the display, press the **HOLD** key.**  
The latest measured values will be hold and the HOLD LED lights up.
4. **Press the key.**  
The measured color of the display will be set as the target color.
5. **Press the **HOLD** key to start measurement.**  
The HOLD LED will go out.

Memory channel

```
CH01 EXT Ad P1U
[ ]
```

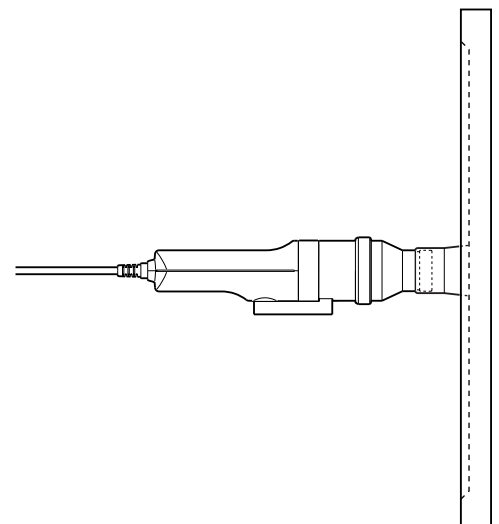

\* To view the target color you set, press the **MR** key.  
(For details, refer to page 72.)

\* By default (factory setting),  $x=0.3127$ ,  $y=0.3293$  and  $L_v=160.0$  (cd/cm<sup>2</sup>) are set for each memory channel.

## <Notes when Setting/Changing the Target Color by Measurement>

- Note that the target color is common to all measurement modes (xyLv, TΔuvLv, analyzer, u'v'Lv, XYZ).
- If the intensity of the display to be measured is 1.0 cd/m<sup>2</sup> or less (3.0 cd/m<sup>2</sup> or less when a Small Universal Measuring Probe(CA-PSU12/15) or Small LCD Flicker Measuring Probe(CA-PS12/15) is connected.) or if the ambient temperature has changed, zero calibration must be performed before setting the target color.
- Static electricity on the display's screen surface must be removed as much as possible.
- Make sure that the measuring probe is placed straight against the display. If it is tilted or moved, it is not possible to input accurate target color.
- Take care not to let the measuring probe be exposed to excessive impact. In addition, do not pull or bend the cord excessively or exert excessive force on it. Failure to observe this may result in breakdown or wire-breakage.
- If "OVER" is currently displayed, it is not possible to set the currently measured color as the target color since the instrument's measurement range is exceeded.

---

## <Error Messages in LCD Display Section> ... For other error messages, refer to page 103.

- "OVER" (after the **HOLD** key is pressed)
  - It is not possible to set the currently measured color as the target color since the instrument's measurement range is exceeded by the measured value.
- "E1"
  - Cause : The target color was set using a measuring probe which is different from the one used to perform user calibration/input the RGB emission characteristic for the analyzer mode.
  - Action : ① Set the target color using the measuring probe that was used to perform user calibration/input the RGB emission characteristic for the analyzer mode.
  - ② Perform user calibration/input the RGB emission characteristic for the analyzer mode again using a measuring probe connected to the instrument, and then set the target color.



OVER

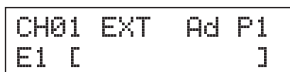

CH01 EXT Ad P1  
E1 [ ]

\* For a description of how to check the probe serial no., refer to page 74.

## 2. Setting/changing the target color by entering values

This method can be used for memory channel CH00 only.

### [Operating Procedure]

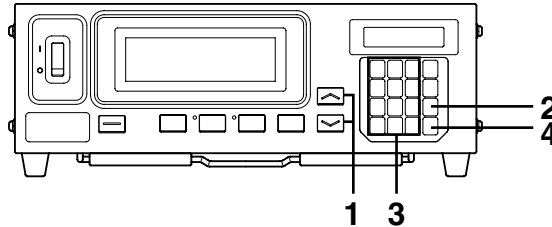

#### When the optional 4-Probe Expansion Board CA-B14 is used

Select the probe no. to which you want to set the target color. The target color can be set independently for each probe connector ([P1] to [P5]) for each memory channel.

- ① **Press the key.**  
The LCD display section will switch to the menu selection screen.
- ② **Press the key to open the PROBE selection screen.**  
Each time the key is pressed, the screen will switch in the order PROBE → SYNC → ID Name input → RANGE → Measurement Speed → Number of Digits → Calibration Standard → RS232C Baud Rate → PROBE.
- ③ **Press the key to display the probe no. you want to select.**  
Each time the key is pressed, the probe no. switches in the order [P1] ...
- ④ **Press the key to confirm the selection.**

Menu selection screen

```
MENU : SELECT
PUSH SPACE KEY
```

PROBE selection screen

```
SELECT : PROBE
P1 35881112 U
```

```
SELECT : PROBE
P3 35881113
```

Probe no.

Press the key until the desired probe no. appears.

1. Press the MEMORY CH and keys until the memory channel CH00 appears.

Memory channel

```
CH00 EXT Ad P1U
[ ]
```

2. Press the key.

In the LCD display section, the current target color values are displayed.

```
CH00 x y Lv P1
3127 3293 160.0
```



### <Error Messages in LCD Display Section> ... For other error messages, refer to page 101.

- "E3" (after the key is pressed)
  - Cause : An attempt was made to set Incorrect target color values.  
Incorrect calibration values mean the following.
    - ① One of x, y and Lv is "0".
    - ②  $1-x-y \leq 0$
    - ③ Values which are beyond the instrument's calculation capability or contradicting values.
  - Action : Enter correct values and then press the key.

```
E3 x y Lv P1
0000 3293 160.0
```

### 3. Enter target color values (x, y, Lv).





For x and y, a value 10000 times the calibration value must be entered.

Use the number-key (  to ,  ) to enter the value.

The cursor moves to the right each time a value is entered.





Each time the  key is pressed, the cursor moves in the order  $x \rightarrow y \rightarrow Lv \rightarrow x$ .

In this example,  $x=0.3300$ ,  $y=0.3000$  and  $Lv=39.50$  are entered.

① Press the , ,  and then  key to enter the “x” value.





② Press the  key.

The cursor (  ) will move to “y”.

③ Press the , ,  and then  key to enter the “y” value.

④ Press the  key.

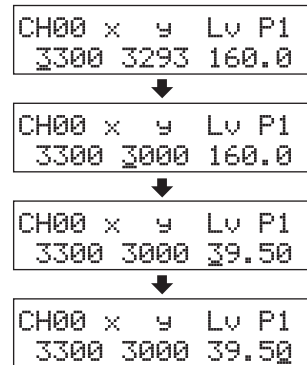

The cursor (  ) will move to the “Lv” position.

⑤ Press the , , ,  and then  key to enter the “Lv” value.



### 4. Press the key.

The target color will be set to CH00.

\* To cancel target color setting, press the  key before pressing the  key.

\* To view the target color you set, press the  key. (For details, refer to page 73.)

\* By default (factory setting),  $x=0.3127$ ,  $y=0.3293$  and  $Lv=160.0$  (cd/m<sup>2</sup>) are set for the memory channels for which no target color has been set.

### <Notes when Setting/Changing the Target Color>

- The  key may not be operable if “OVER” is displayed on the LCD display section.
- Note that the target color is common to all measurement modes (xyLv, TΔuvLv, analyzer, u'v'Lv, XYZ).
- Never press the following keys during target color setting.

Doing so will cancel setting and activate the mode corresponding to the pressed key.

( , , , , MEMORY CH , ,  )

# Other Settings

## 1. Setting an ID Name

An ID name is a name that can be assigned to each memory channel by entering it directly using keys.

When measurement is performed, the ID name is displayed together with the memory channel no. and probe no. in the LCD display section.

- Number of characters you can enter ..... Up to 10 characters
- Type of characters you can enter ..... “1” to “9”, “.” (comma), “A” to “Z”, “—”, “ ” (space)

For instance, if you set “EXT D-1.50” for CH01, the LCD display section will look like the one shown on the right.

This function is useful when you want to specify that user calibration and target color have been set for what type of display with what colors.

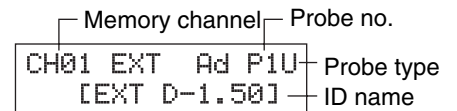

### [Operating Procedure]

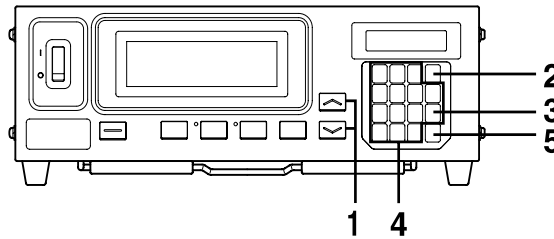

**1. Press the MEMORY CH and keys until the memory channel to which you want to set an ID name appears.**

**2. Press the key.**

The LCD display section will switch to the menu selection screen.

**3. Press the key to open the ID name input screen.**

Each time the key is pressed, the screen will switch in the order PROBE → SYNC → ID Name input → RANGE → Measurement Speed → Number of Digits → Calibration Standard → RS232C Baud Rate → PROBE.

**4. Enter the desired ID name.**







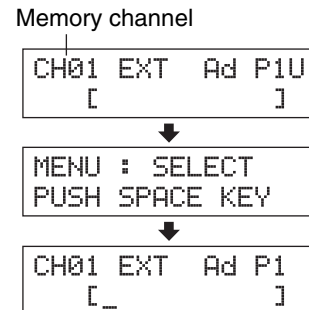





Number-key (, to , ) ..... Used to enter values. (The cursor moves to the right each time a value is entered.)

key ..... The , , and keys on the key panel can be used to enter an alphabet, hyphen (-) and space. Pressing this key again will restore the original function of the number-key.

key ..... Moves the cursor to the right each time this key is pressed.



In this example, “EXT D-1.50” is set as the ID name.

- ① Press the  key.
- ② Press the  key twice.  
“E” will appear at the cursor position.
- ③ Press the  key twice.  
“X” will appear at the cursor position.
- ④ Press the  key once.  
“T” will appear at the cursor position.
- ⑤ Press the  key twice.  
“ ” will appear at the cursor position.
- ⑥ Press the  key once.  
“D” will appear at the cursor position.
- ⑦ Press the  key once.  
“-” will appear at the cursor position.
- ⑧ Press the  key.
- ⑨ Press the  key.  
“1” will appear at the cursor position.
- ⑩ Press the ,  and then  key.  
“.”, “5” and then “0” will appear at the cursor position.

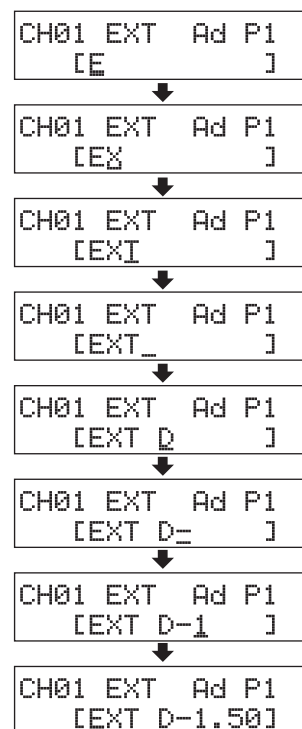

## 5. Press the key.







The ID name will be set for the selected memory channel.



\* To cancel ID name setting, press the  key.

### <Notes when Setting an ID Name>

- The ID name will be kept even if the POWER switch is set to OFF.
- Never press the following keys during ID name setting.

Doing so will cancel setting and activate the mode corresponding to the pressed key.

( , , , , MEMORY CH ,  )

If the  key is pressed while the  key is not held down (i.e. the number-key is not used as alphabet key), a screen for setting the analog display range will appear.

- **When the optional 4-Probe Expansion Board CA-B14 is used**

Only one ID name can be set for each memory channel irrespective of the number of probes. (The specified ID name will be common to all probes [P1] to [P5].)

## 2. Setting the Analog Display Range

The analog display section displays the difference (%) between the measured value and the target color as well as the difference (%) between measured values in the case of a measurement mode other than flicker mode\*\*. In the case of flicker mode, the measured values will be displayed as they are.

The range for each dot can be set as follows.

- ① xyLv, TΔuvLv, u'v'Lv or XYZ measurement mode ..... Δx, Δy and ΔLv
- ② Analyzer Mode
  - For G-reference ..... R/G, B/G and ΔG
  - For R-reference ..... ΔR, B/R and G/R

- ③ Flicker Mode\*\* ..... Flicker value
- The range must be set independently of ①, ② and ③

In the case of ①, the range set here will be used commonly by all the modes. Thus, for instance, if Δx and Δy are set to 2% and ΔLv is set to 10% for xyLv mode, Δx and Δy will be displayed in 2% and ΔLv in 10% irrespective of the measurement mode (xyLv, TΔuvLv, u'v'Lv or XYZ).

In the case of ②, the value set for ΔG (G-reference), the value set for ΔR (R-reference), the values set for R/G and B/G (G-reference) and those set for B/R and G/R (R-reference) will be common. Thus, for instance, if ΔG is set to 5% and both R/G and B/G are set to 3% in the case of G-reference, ΔR will be displayed in 5% and both B/R and G/R in 3% in the case of R-reference.

In the case of ③, the analog display range for each dot can be set for flicker value.

- Settable range ..... 0.1 to 99%
  - └ In 0.1% step for the range from 0.1 to 9.9%
  - └ In 1% step for the range from 10 to 99%

- How to Read Analog Display

When n% range is set

**For xyLv, TΔuvLv, analyzer, u'v'Lv or XYZ mode**

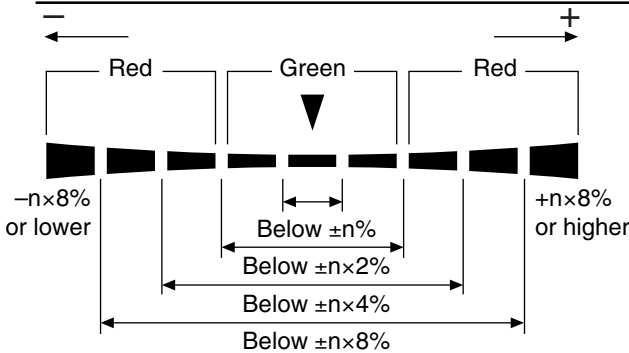

**For flicker mode\*\***

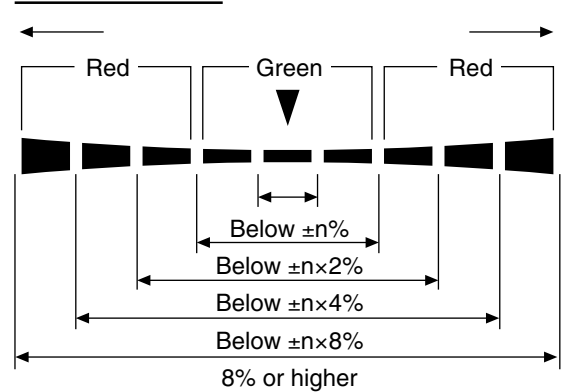

- Values displayed in the analog display section

**For xyLv, TΔuvLv, u'v'Lv or XYZ mode**

$$\Delta x = \left( \frac{x - x_t}{x_t} \right) \times 100 (\%)$$

$$\Delta y = \left( \frac{y - y_t}{y_t} \right) \times 100 (\%)$$

$$\Delta Lv = \left( \frac{Lv - Lv_t}{Lv_t} \right) \times 100 (\%)$$

where,  $x_t, y_t, Lv_t$  : Target color values  
 $x, y, Lv$  : Measured values

\*\*Flicker Mode is a function which can be used only when LCD Flicker Measuring Probe(CA-P12/15) or Small LCD Flicker Measuring Probe(CA-PS12/15) is connected.

**For analyzer mode (G reference)**

$$R/G = \left( \frac{R-G}{G} \right) \times 100 (\%)$$

$$B/G = \left( \frac{B-G}{G} \right) \times 100 (\%)$$

$$\Delta G = \left( \frac{G-G_t}{G_t} \right) \times 100 = G - 100 (\%)$$

**For analyzer mode (R reference)**

$$\Delta R = \left( \frac{R-R_t}{R_t} \right) \times 100 = R - 100 (\%)$$

$$B/R = \left( \frac{B-R}{R} \right) \times 100 (\%)$$

$$G/R = \left( \frac{G-R}{R} \right) \times 100 (\%)$$

where  $G_t, R_t$  : Target color values, being 100

$R, G, B$  : Measurement Values

**For flicker mode\*\***

Measured values are displayed as they are. The display lights up crosswise.

- Display examples

$\Delta x = 15\%$  when set to 2%

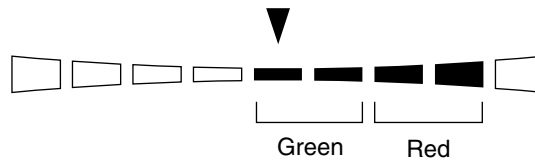

Measured flicker 13% when set to 5%

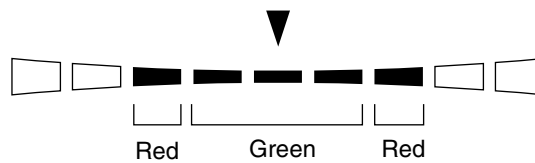



## [Setting Procedure]

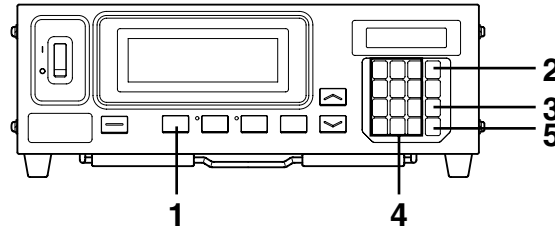

1. Press the **MODE** key to select the measurement mode for which you want to set the range.

2. Press the **MENU** key.

The LCD display section will switch to the menu selection screen.

3. Press the **RANGE** key to open the RANGE setting screen.

Each time the **RANGE** key is pressed, the screen will switch in the order PROBE → SYNC → ID Name input → RANGE → Measurement Speed → Number of Digits → Calibration Standard → RS232C Baud Rate → PROBE.

4. Enter the desired range value.

Use the number-key (0 to 9, **DEL**) to enter the value. (The cursor moves to the right each time a value is entered.)

Each time the **←** key is pressed, the cursor moves between x, y and Lv, between G and B/G, R/G or between R and B/G, R/G. (This does not apply in the case of flicker mode\*\*.)

In this example, the “x, y” range is set to 2.5%, and the “Lv” range is set to 2.0%.

① Press the **2**, **5** and then **ENTER** key to set the “x, y” range.

② Press the **←** key.

The cursor ( ) will move to the “Lv” position.

③ Press the **2**, **0** and then **ENTER** key to set the “Lv” range.

5. Press the **ENTER** key.

The ranges will be set.

\* To cancel range setting, press the **RANGE** key before pressing the **ENTER** key.

\* By default (factory setting), the ranges are set to 10%.

Menu selection screen

```
MENU : SELECT
PUSH SPACE KEY
```



Range setting screen

(For xyLv, TΔuvLv, u'v'Lv or XYZ mode)

```
RANGE x,y Lv
(%) 10 10
```

For analyzer mode (G reference)

```
RANGE G B/G,R/G
(%) 10 10
```

For analyzer mode (R reference)

```
RANGE R B/R,G/R
(%) 10 10
```

For flicker mode\*\*

```
RANGE FMA
(%) 10
```

```
RANGE x,y Lv
(%) 2.5 10
```



```
RANGE x,y Lv
(%) 2.5 2.0
```

## <Error Messages in LCD Display Section> ... For other error messages, refer to page 103.

● “E4” (after the **ENTER** key is pressed)

• Cause : 0.0% was entered.

• Action : Enter a correct value and then press the **ENTER** key. The settable range is from 0.1 to 99%.



```
RANGE x,y Lv
E4(%) 0.0 10
```

\*\*Flicker Mode is a function which can be used only when LCD Flicker Measuring Probe(CA-P12/15) or Small LCD Flicker Measuring Probe(CA-PS12/15) is connected.

## <Notes on Range Setting>

- The range settings will be kept even if the POWER switch is set to OFF (○). The specified analog range will be effective when the POWER switch is set to ON (|).
- The specified range settings are common to all the probe nos. and memory channels.
- Keys may not be operable if “OVER” is displayed on the LCD display section.
- Never press the following keys during range setting.

Doing so will cancel range setting and activate the mode corresponding to the pressed key.

( 0-CAL, MODE, REMOTE, MR, MEMORY CH ,  )

## <Digital and Analog Display>

In the case of four-digit digital display, measured values are displayed in four digits with the fifth digit rounded off. Similarly, in the case of three-digit digital display, measured values are displayed in three digits with the fourth digit rounded off.

However, the values calculated from the digital display may not match the values displayed in the analog display section.

# Settings Checking Method

## 1. Checking the Set Values

### <Checking the Specified Target Color>

By pressing the **MR** key for less than two seconds in xyLv, TΔuvLv, u'v'Lv or XYZ mode, the values of the target color for the currently selected memory channel is displayed in the LCD display section as shown on the right.

CH01	x	y	Lv	P1
M3189	4079	366.0		

**When the optional 4-Probe Expansion Board CA-B14 is used**

The values of the target color for the currently selected memory channel probe no. will be displayed.

### <Checking the Calibration Values for User Calibration>

#### ● When white calibration is performed as user calibration

- ① If only user calibration has been performed, the calibration values can be checked by checking the target values. Since when user calibration is performed the color at the time of user calibration will be set as the target color automatically, the target color values match the calibration values. However, if a different color is set as the target color after user calibration, it is not possible to check the calibration values with this method.

- ② It is possible to check the calibration value for W by performing steps 5 and 6 ( **SPACE** **CAL** key → **White** **1** key ) of the white calibration operating procedure (page 53).

The value that appears first when the **White** **1** key is pressed is the calibration value that was entered when the previous user calibration was performed. The values for the target color will be displayed if user calibration has not been performed.

#### ● When matrix calibration is performed as user calibration

- ① If only user calibration has been performed, the W calibration values can be checked by checking the target values. Since when user calibration is performed the color at the time of W calibration will be set as the target color automatically, the target color values match the W calibration values. However, if a different color is set as the target color after user calibration, it is not possible to check the calibration values with this method.

- ② It is possible to check the calibration value for W by performing steps 5 and 6 ( **SPACE** **CAL** key → **White** **1** key ) of the white calibration operating procedure (page 53).

The value that appears first when the **White** **1** key is pressed is the calibration value that was entered when the previous user calibration was performed. The values for the target color will be displayed if user calibration has not been performed.

- ③ To check the calibration values for R, G and B, perform steps 4 then 5 ( **SPACE** **CAL** key → **Red** **0** key ), steps 4 then 6 ( **SPACE** **CAL** key → **Green** **2** key ) or steps 4 and then 7 ( **SPACE** **CAL** key → **Blue** **3** key ) of the matrix calibration operating procedure (page 55).

The value that appears first when these keys are pressed is the calibration value that was entered when the previous user calibration was performed. "0" will be displayed for R, G and B if user calibration has not been performed.

## 2. Checking the Probe Serial No. when Making Settings

**Period for which the **MR** key is pressed** To check the probe serial no. when making settings, press the **MR** key for two to four seconds (a bleep will sound after two seconds have elapsed)

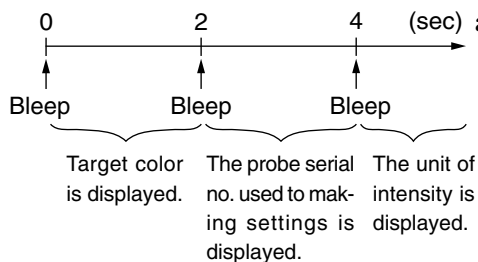

and check it in the LCD display section.

### <When xyLv, TΔuvLv, u'v'Lv or XYZ mode is selected>

The serial number of the probe used when user calibration is performed or when target color is set will be displayed.

#### When the optional 4-Probe Expansion Board CA-B14 is used

The probe serial no. of the probe connector used for the current selected memory channel will be displayed.

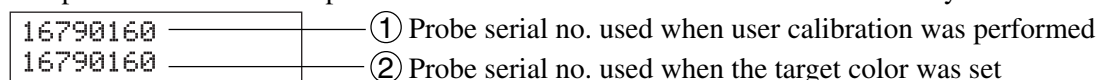

By default (factory setting), “00000000” is set for both ① and ②.

- When “00000000” is set for ①: If measurement is performed with this memory channel, Konica Minolta’s calibration standard will be used for the measurement. (Same as when measurement is performed with the memory channel CH00.)
- When “00000000” is set for ②:  $x=0.3127$ ,  $y=0.3293$  and  $L_v=160.0$  (cd/m<sup>2</sup>) are set as the values of the target color.

### <When an analyzer measurement mode is selected>

The probe serial no. that was used to input the analyzer mode RGB emission characteristic or set the target color for the currently selected memory channel will be displayed.

#### When the optional 4-Probe Expansion Board CA-B14 is used

The probe serial no. of the probe connector used for the current selected memory channel will be displayed.

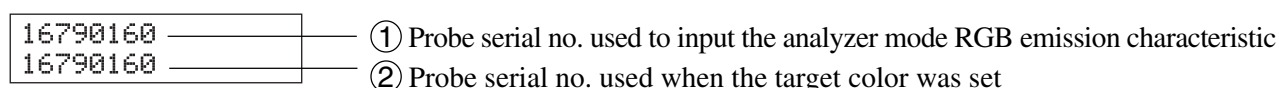

By default (factory setting), “00000000” is set for both ① and ②.

- When “00000000” is set for ①: The RGB emission characteristic for the display’s analyzer mode has not been input.

\* The serial no. of the currently used measuring probe can be viewed in the PROBE selection screen, that can be opened by pressing the **MR** key then **SW** keys.

(If the 4-Probe Expansion Board is used, the probe no. will switch from one to another each time the **Blue** key is pressed. For details, refer to page 43.)

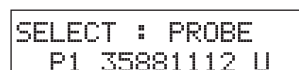

### <When flicker measurement mode\*\* is selected>

“00000000” will be displayed for both data lines.

\*\*Flicker Mode is a function which can be used only when LCD Flicker Measuring Probe(CA-P12/15) or Small LCD Flicker Measuring Probe(CA-PS12/15) is connected.

# Measurement Section

This section explains measuring methods.

## From the Settings Section



<b>Measurement</b> Explains measuring methods, how to hold the measured values and how to read them.	Page 76
<b>White Balance Adjustment in Analyzer Mode</b> Explains how to adjust white balance.	Page 81



# Measurement

Before starting measurement, perform the following.

Installation/Connection section (page 23)	Install the instrument, connect the power cable, and turn ON the power.
Measurement Preparation section (page 33)	Perform preparations (instrument setting, zero calibration) that are required prior to measurement.
Settings section (page 45)	Set up the instrument according to the setting method. This is not necessary if the instrument has already been set up or if you are going to perform measurement using Konica Minolta's calibration standard and are not going to use the analog display function

## 1. Performing Measurement

### [Measuring Method]

1. Press the MEMORY CH  and  keys. keys to select the memory channel for which user calibration has been performed (page 51), the RGB emission characteristic for analyzer mode that has been input (page 59) and the target color that has been set/changed (page 62).

(Not required in the case of flicker measurement)

2. Place the measuring probe flat against the display and perform measurement.

The measurement results will be displayed in the digital and analog display sections in the selected measurement mode.

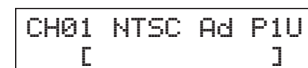

CH01 NTSC Ad P1U  
[ ]

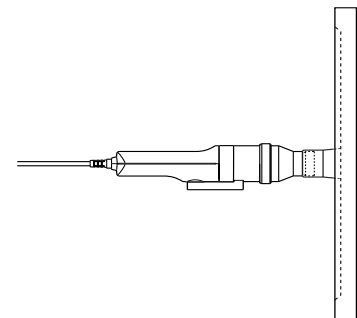

### <Notes on Measurement>

- Since the luminance of the display will be unstable for a while immediately after the display is turned ON, the measured values must be read after they have stabilized.
- Static electricity on the display's screen surface must be removed as much as possible.
- Perform zero calibration if the ambient temperature has changed.
- When measuring a display at a low luminance level of 1.0 cd/m<sup>2</sup> or less (3.0 cd/m<sup>2</sup> or less when a Small Universal Measuring Probe(CA-PSU12/15) or Small LCD Flicker Measuring Probe(CA-PS12/15) is connected.) for a long period of time, perform zero calibration approximately every hour.
- Make sure that the measuring probe is placed straight against the display. If it is tilted or moved, accurate measurement cannot be performed.
- Take care not to let the measuring probe be exposed to excessive impact. In addition, do not pull or bend the cord excessively or exert excessive force on it. Failure to observe these cautions may result in breakdown or wire-breakage.
- When measurement is implemented, the same Measuring Probe to be used for the User Calibration is necessary.
- For measurement of flicker(only when LCD Flicker Measuring Probe(CA-P12/15) or Small LCD Flicker Measuring Probe(CA-PS12/15) is connected.), make sure that the correct vertical synchronizing frequency is recognized by the instrument. If an incorrect vertical synchronizing frequency is set in the INT mode or instrument is used in the UNIV mode, correct measured values will not be obtained in flicker measurement.

#### When the optional 4-Probe Expansion Board CA-B14 is used

- If two or more measuring probes are connected, measurement will be performed with all the probes simultaneously. However, the digital and analog display sections show only the measurement results taken by the one selected probe (page 43).

## 2. Holding the Measured Values

- To hold the measured values, press the **HOLD** key. The HOLD LED will light up. (Hold mode)  
Pressing the **HOLD** key again will cancel hold mode and resume measurement. This will cause the HOLD LED to go out.

\* If the conditions (e.g. measurement mode) set for hold mode are changed, the measured values that are currently hold will be re-calculated according to the new conditions and then displayed. (This does not apply in the case of SYNC mode.)

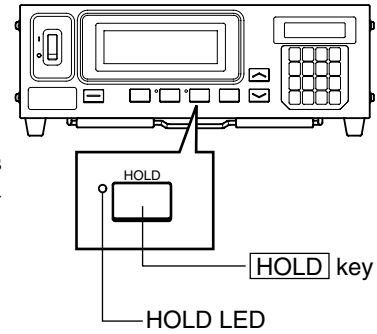

### <Notes on when Holding the Measured Values>

- It is not possible to hold the measured values in the following cases.
  - Until the measured values appear after the POWER switch is set to ON and then **0-CAL** key is pressed
  - Until the measured values appear after the **0-CAL** key is pressed
  - When the error message "NO SYNC. SIGNAL" is currently displayed in the LCD display section
- To cancel hold mode, press the **0-CAL** key.

## 3. Displaying the Measured Values

### <For xyLv, TΔuvLv, u'v'Lv or XYZ Mode>

The measurement results will be displayed in the digital and analog display sections.

- The digital display section shows the measurement results.  
All measurement values can be acquired by communicating with PC, however the display of the main unit always displays measurement values 3 to 5 times / second and does not display all the measurement values.

Please see P. 41 for measuring modes.

According to the selection of number of digits to be displayed (P. 42), an effective number of 3 or 4 digits will be displayed. However, Correlated Color Temperature T will always be displayed with an effective number of 3 digits. For Δuv, a Color Difference from Blackbody Locus, 0 of the integer will not be displayed when the value is minus. It will be displayed like "-.0092". Luminance Lv will be displayed to two digits to the right of the decimal.

The range to be displayed for TΔuvLv mode is as follows.

$$2300 \leq T \leq 20000 \text{ (K)}$$

$$|\Delta uv| < 0.1$$

The range to be displayed for Luminance Lv is as follows.

When Universal Measuring Probe(CA-PU12/15) or LCD Flicker Measuring Probe(CA-P12/15) is connected:  $L_v \leq 1000(\text{cd}/\text{m}^2)$

When Small Universal Measuring Probe(CA-PSU12/15) or Small LCD Flicker Measuring Probe(CA-PS12/15) is connected:  $L_v \leq 3000(\text{cd}/\text{m}^2)$

- The analog display section shows the difference between the measured value and the target color in percentage (%).
  - Display contents: Δx, Δy, ΔLv

\* For details on the analog display function and how to set the range for each dot, refer to page 69.

- When the analog display range is set to n%

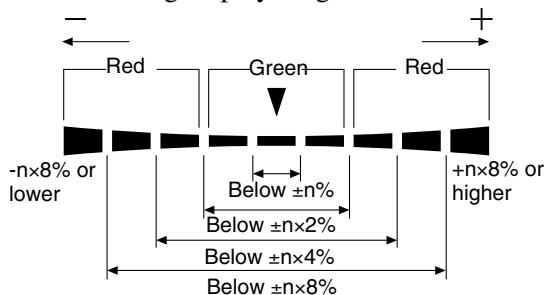

For xyLv or u'v'Lv mode

x	0.3121	Δx	□□□□
y	0.2801	Δy	□□□□
Lv	84.10	ΔLv	□□□□

For TΔuvLv mode

T	5560	Δx	□□□□
Δuv	0.0092	Δy	□□□□
Lv	84.18	ΔLv	□□□□

For XYZ mode

	75.41	Δx	□□□□
	84.01	Δy	□□□□
	53.53	ΔLv	□□□□

For u'v'Lv mode

u'	0.1977	Δx	□□□□
v'	0.4685	Δy	□□□□
Lv	160.00	ΔLv	□□□□

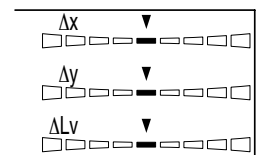

## <For Analyzer Mode>

If analyzer measurement mode is selected, measurement results will be displayed as shown below.

### ● Digital display section

- Display contents : R, B, G

Outputs of the currently measured monochrome lights R, B and G in ratio (%) to those of the specified target color (W)

- Display range : The range to be displayed:  
When the effective number of digits is 3 digits to 99900(%)  
When the effective number of digits is 4 digits to 99990(%)  
An effective number that has been set in the selection of number of digits to be displayed (P.42) will be displayed. However only to two digits to the right of the decimal will be displayed.

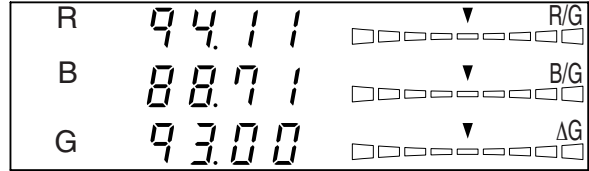

### ● Analog display section

- Display contents : When analyzer mode (G-standard) is selected  
R/G, B/G: Ratio of measured values  
 $\Delta G$ : Difference from the target color in the case of monochrome light G

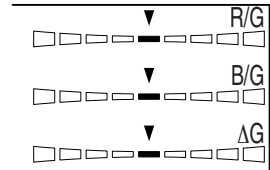

- When analyzer mode (R-standard) is selected  
 $\Delta R$ : Difference from the target color in the case of monochrome light R  
G/R, B/R: Ratio of measured values

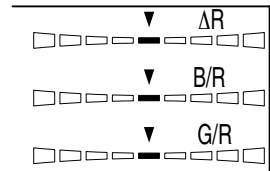

\* For details on the analog display function and how to set the range for each dot, refer to page 67.

### ● When the analog display range is set to n%

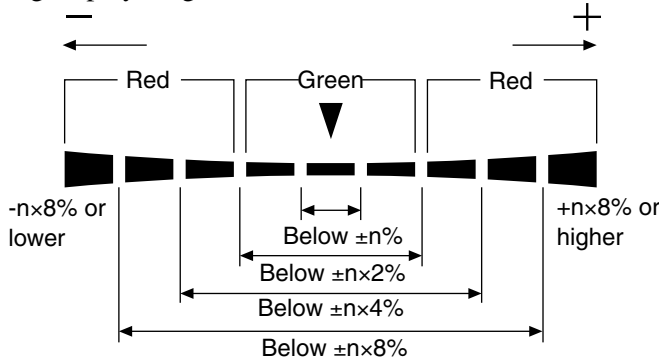

## <Out of Measurement Range>

### [For xylv, T $\Delta$ uvLv, u'v'Lv or XYZ, Analyzer Mode]

- When the measurement range is exceeded  
Digital display : “-----”  
Analog display : Not lit  
LCD display : “OVER”

### [For T $\Delta$ uvLv Mode]

- T or  $\Delta$ uv are out of the display range  
Digital display : “-----”  
(T and  $\Delta$ uv)

### [For Flicker Mode]

- When the measured value has exceeded 100.00%  
Digital display : “-----”  
Analog display : Not lit  
LCD display : “FLICKER ERROR OVER”



## <For Flicker Mode>

Flicker Mode is a function which can be used only when LCD Flicker Measuring Probe(CA-P12/15) or Small LCD Flicker Measuring Probe(CA-PS12/15) is connected.

### When the optional 4-Probe Expansion Board CA-B14 is used

In Flicker Mode with LCD Flicker Measuring Probe(CA-P12/15) or Small LCD Flicker Measuring Probe(CA-PS12/15) connected, a selected probe cannot be changed to Universal Measuring Probe(CA-PU12/15) or Small Universal Measuring Probe(CA-PSU12/15).

If flicker measurement mode is selected, measurement results will be displayed as shown below.

#### ● Digital display section

- Display contents : Contrast flicker value (%)
- Display range : 0.0 to 100% (up to the first decimal place)

Flicker mode

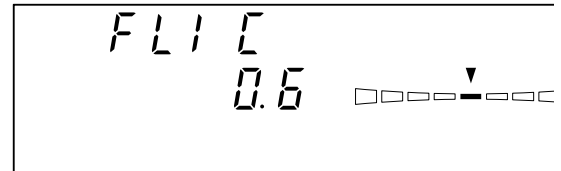

#### ● Analog display section

- Display contents : Contrast flicker value (%)

\* For details on the analog display function and how to set the range for each dot, refer to page 69.

#### ● When the analog display range is set to n%

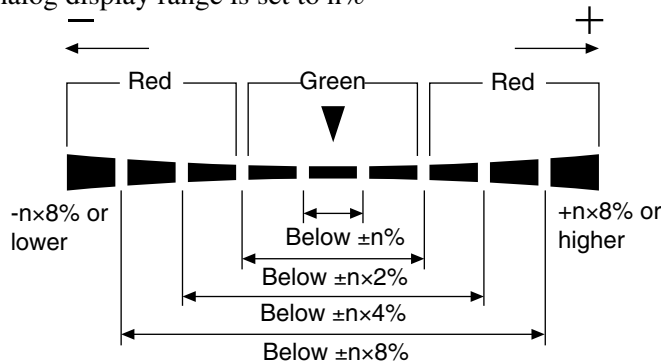

#### ● Measurement range for flicker mode

The average luminance ( $L_v$ ) is 5.0 cd/m<sup>2</sup> or above (15.0 cd/m<sup>2</sup> or above when a Small Measuring Probe is connected.) or above and the maximum luminance ( $L_v$ ) is 1000 cd/m<sup>2</sup> or less (3000 cd/m<sup>2</sup> or less when a Small Measuring Probe is connected.) in the case of white calibration with Konica Minolta's calibration standard.

Vertical scanning frequency 40 to 130 Hz

## <About Low-Luminance Warning>

### [For xylv, TΔuvLv, u'v'Lv or XYZ, Analyzer Mode]

- When  $L_v$  (luminance) is under the following minimum values (white calibration equivalent to Konica Minolta's calibration standard)
 

Digital display	: blinking
Analog display	: blinking
Measurement mode	: blinking

under 0.1 cd/m<sup>2</sup> for Universal Measuring Probe(CA-PU12/15), LCD Flicker Measuring Probe(CA-P12/15)  
under 0.3 cd/m<sup>2</sup> for Small Universal Measuring Probe(CA-PSU12/15), Small LCD Flicker Measuring Probe(CA-PS12/15)

### [For Flicker Mode]

- When  $L_v$  (luminance) is the following (Konica Minolta's white calibration standard)
 

Digital display	: blinking
Analog display	: blinking
Measurement mode	: blinking

under 5cd/m<sup>2</sup> for LCD Flicker Measuring Probe (CA-P12/15)  
under 15cd/m<sup>2</sup> for Small LCD Flicker Measuring Probe (CA-PS12/15)
- When  $L_v$  (luminance) is the following
 

Digital display	: “- - - - -”
Analog display	: Not lit
LCD display	: “FLICKER ERROR UNDER”

under 0.1cd/m<sup>2</sup> for LCD Flicker Measuring Probe (CA-P12/15)  
under 0.3cd/m<sup>2</sup> for Small LCD Flicker Measuring Probe (CA-PS12/15)

## <Error Messages in LCD Display Section>

For other error messages, refer to page 101.

### ● “OVER”

- Measurement is not possible since the instrument’s measurement range is exceeded by the measured value.

In the case of analyzer mode, the instrument’s measurement range or display range (100,000%) is exceeded by the measured value.

```
OVER
```

### ● “E1”

- Cause : In the case of xyLv, TΔuvLv, u'v'Lv or XYZ measurement mode, the currently used measuring probe is different from the one used to perform user calibration and set the target color. In the case of analyzer mode, the currently used measuring probe is different from the one used to input RGB emission characteristic for analyzer mode and set the target color (W).

- Action: Use the same probe as the one used to input the RGB emission characteristic and set the target color. Alternatively, input the RGB emission characteristic and set the target color using the currently used measuring probe.

```
CH01 NTSC Ad P1  
E1 [ ]
```

```
CH01 NTSC Ad P1  
E2 [ ]
```

### ● “E2”

- Cause : An error has occurred due to shift of the zero point because the ambient temperature has changed since zero calibration.
- Action: Perform zero calibration.

\* Measurement can still be performed even if “E2” is currently displayed.

\* “E2” will not appear if “E1” is currently displayed.

---

## [For Flicker Mode\*\*]

### ● “FLICKER ERROR UNDER”

- Measurement is not possible since Lv is below 0.1 cd/m<sup>2</sup> (0.3 cd/m<sup>2</sup> when a Small LCD Flicker Measuring Probe(CA-PS12/15) is connected.)(white calibration with Konica Minolta’s calibration standard).

```
FLICKER ERROR  
UNDER
```

### ● “FLICKER ERROR OVER”

- Measurement is not possible since flicker value is beyond 100.0%.

```
FLICKER ERROR  
OVER
```

### ● “FLICKER ERROR VSYNC OVER”

(EXT is selected as the SYNC mode)

- Measurement is not possible since the frequency of the vertical synchronizing signal input to this instrument is beyond 130 Hz.

(INT is selected as the SYNC mode)

- Measurement is not possible since the currently set vertical scanning frequency is beyond 130 Hz.

```
FLICKER ERROR  
VSYNC OVER
```

### ● “FLICKER ERROR PROBE TYPE”

- Cannot measure as the measured probe is not for LCD Flicker Measuring.

```
FLICKER ERROR  
PROBE TYPE
```

---

\*\*Flicker Mode is a function which can be used only when LCD Flicker Measuring Probe or Small LCD Flicker Measuring Probe is connected.

# White Balance Adjustment in Analyzer Mode

## <About Analyzer Mode>

Analyzer measurement mode is provided for adjustment of the display's white balance.

The measured colors are expressed in emission intensity of each R, B and G monochromatic light based on the RGB emission characteristic for analyzer mode (page 59) and the target color (W) which are set to the instrument. Thus, adjusting the emission intensity of R causes the measured value of R only to change, and measured values for B and G remain unchanged.

This mode is useful when you adjust the emission intensity of R, B and G to match the target color (W).

## <White Balance Adjustment in Analyzer Mode>

First, set the RGB emission characteristic for analyzer mode and the target color (W) to the instrument.

For the target color (W), the values of the white-balanced white must be entered. (Page 59)

If "100" is displayed for R, B and G in the digital display section when measurement is performed in analyzer mode, this indicates that the color of the display measured is the same as the target color (W) (i.e. the xyLv values are the same) for the selected memory channel. In the analog display section, only the center green segments light up.

When each display of R, B, G of the digital display part are a same value except for 100, that means the chromaticity coordinate is same as the standard color (W) although Lv (Luminance) is different. Even if the intensity of the display changes, the chromaticity coordinates (x, y) are the same as those of the target color (W) as long as the values for R, B and G are the same.

R	100.0
B	100.0
G	100.0

R	10.00
B	10.00
G	10.00

## <About G-Standard and R-Standard>

G-Standard or R-Standard must be chosen according to the display whose white balance is to be adjusted.

- G-Standard: Must be used for displays whose G output cannot be adjusted independently.
- R-Standard: Must be used for displays whose R output cannot be adjusted independently.

\* Any of G-standard and R-standard can be used for displays whose R, G and B outputs can be adjusted independently.

# [Operating Procedure]

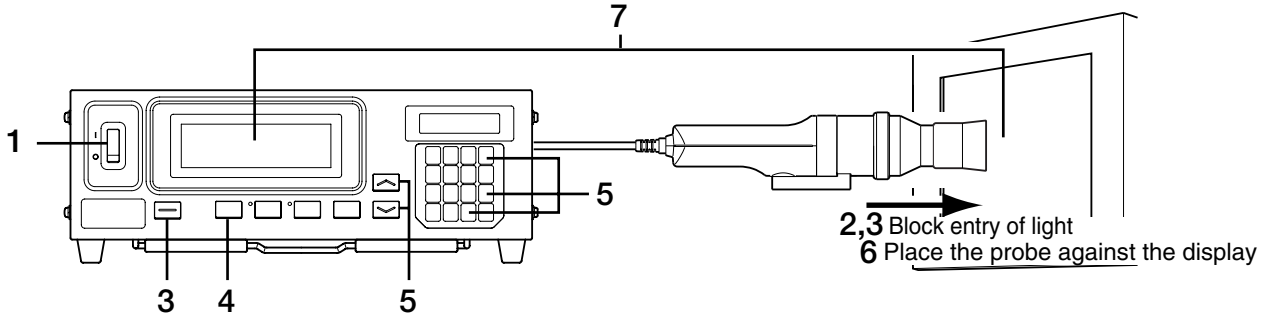

1. Set the POWER switch to ON.
2. Set the 0-CAL ring of the measuring probe to the 0-CAL position.

Never direct the measuring probe toward a high-intensity illuminant.

**When the optional 4-Probe Expansion Board CA-B14 is used**  
Set the 0-CAL ring of every measuring probe to the 0-CAL position. Zero calibration will not be performed correctly if the 0-CAL ring of any of the measuring probes is not set to the 0-CAL position.

3. Press the **0-CAL** key.

After zero calibration is complete, set the 0-CAL ring to the MEAS position and start measurement.

4. Press the **MODE** key to select analyzer measurement mode (RGB).

5. Press the MEMORY CH and keys to select the memory channel for which the RGB emission characteristic for analyzer mode has been set (page 59).

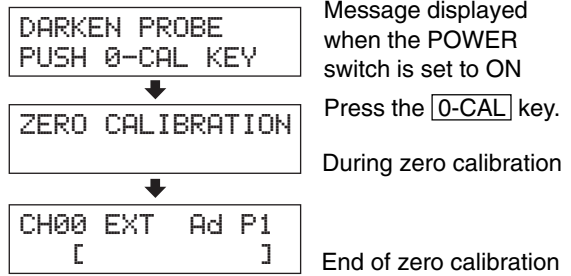

**When the optional 4-Probe Expansion Board CA-B14 is used**

Select the probe no. for which the RGB emission characteristic for the analyzer mode has been input.

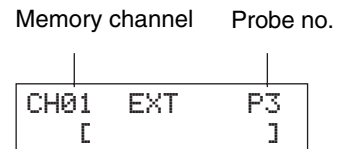

- 1 Press the **MENU** key.  
The LCD display section will switch to the menu selection screen.
- 2 Press the **SPACE CAL** key to open the PROBE selection screen.  
Each time the **SPACE CAL** key is pressed, the screen will switch in the order PROBE → SYNC → ID Name input → RANGE → Measurement Speed → Number of Digits → Calibration Standard → RS232C Baud Rate → PROBE.
- 3 Press the **Blue** key to display the probe no. you want to select.  
Each time the **Blue** key is pressed, the probe no. switches in the order [P1] ....
- 4 Press the **ENTER** key to confirm the selection.

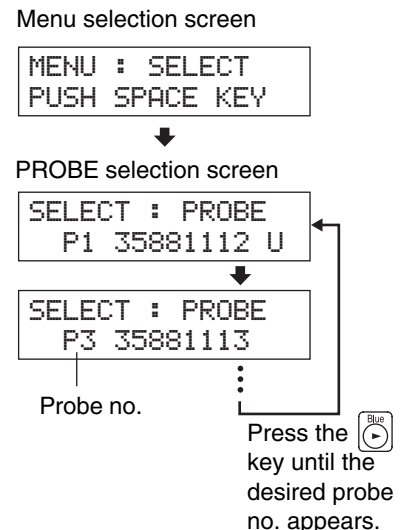

\* By default (factory setting), the instrument is set so that [P1] will be selected automatically when the POWER switch is set to ON(1).

6. Place the measuring probe against the display and take measurement.

## 7. Adjust the white balance.

Normally, white balance is adjusted by adjusting the cutoff and drive voltages. However, in the procedure below, the display is adjusted so that the white generated on the display matches the target color (W) stored in memory.

The method is explained by taking the following cases where the measured values are as follows compared to the target color (W).

- emission intensity of R: Higher by 20%
- emission intensity of B: Lower by 10%
- emission intensity of G: Higher by 10%

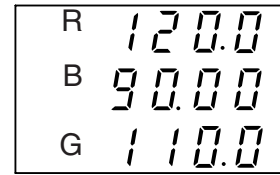

### 7-1. When analyzer mode (G-standard) is selected

- ① Adjust the luminance (or emission intensity of G) so that the displayed value for G changes from “110” to “100.0”.

The other value (R and B) may change somewhat if the intensity is adjust.

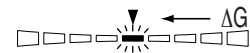
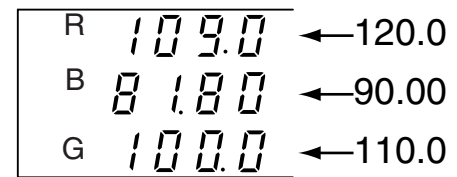

- ② Adjust the out put of R so that the displayed value for R changes from “109.0” to “100.0”, and adjust the out put of B so that the displayed value for B changes from “81.80” to “100.0”.

When all the values for R, B and G are changed to “100.0”, adjustment of the white color of the display to the target color (W) (i.e,the xyLv values are the same) is complete.

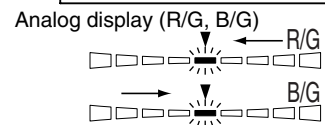
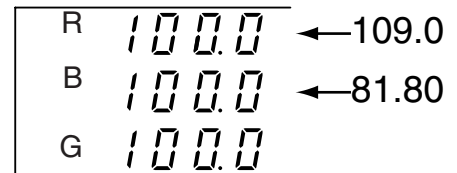

### 7-2. When analyzer mode (R-standard) is selected

- ① Adjust the luminance (or emission intensity of R) so that the displayed value for R changes from “120” to “100”.

The other value (G and B) may change somewhat if the intensity is adjust.

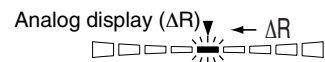
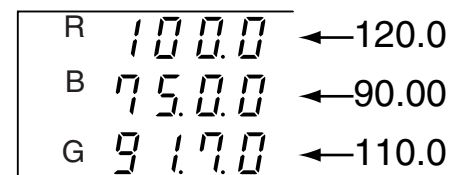

- ② Adjust the out put of B so that the displayed value for B changes from “75.00” to “100.0”, and adjust the out put of G so that the displayed value for G changes from “91.70” to “100.0”.

When all the values for R, B and G are changed to “100.0”, adjustment of the white color of the display to the target color (W) (i.e,the xyLv values are the same) is complete.

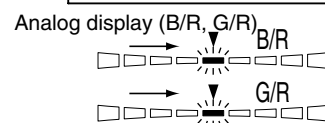
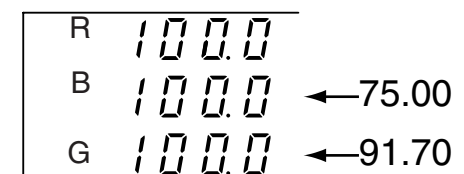

\* The RGB values given in the above example are based on calculations, and may not correspond to the actual display.



# Communications Section

---

This section explains communication with PC via RS-232C or USB.

<b>Communicating with PC via RS-232C</b> Explains how to connect the RS-232C cable and select the RS-232C baud rate to enable two-way communication with PC via RS-232C.	Page 86
<b>Communicating with PC via USB</b> Explains how to connect the USB cable to enable communication with PC via USB.	Page 88
<b>Remote Measurement</b> Explains how to perform measurement from the PC remotely.	Page 88

# Communicating with PC

This instrument allows two-way communication via RS-232C or USB.

## 1. Communicating with PC via RS-232C

Before setting the POWER switch to ON, connect a RS-232C cable (foe 9-pin D-sub Female) to the RS-232C connector on the instrument. Refer to the following for the wiring diagram.

### [Connecting Method]

1. Set the POWER switch to OFF (○).
2. Connect the instrument to the computer with the RS-232C cable.
3. Connect the cable to the connector and secure them with two screws firmly.

- When disconnecting the RS-232C cable, set the POWER switch to OFF(O) first, and pull the cable by holding the plug. Never pull the cable by its cord.

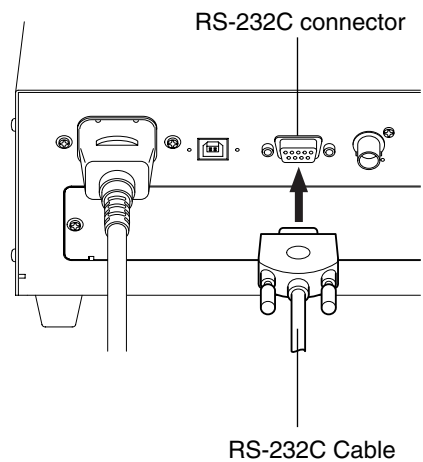

### <Reference Document>

RS-232C Pin Assignment and Cable Wiring Diagram

### Pin Assignment

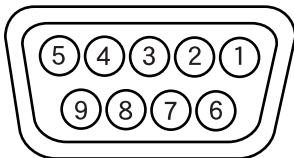

### Wiring Diagram

CA-210

Pin No.	Signal	Input/Output	Description
1	CD	Input	Carrier Detect
2	RXD	Input	Received data
3	TXD	Output	Transmitted data
4	DTR	Output	Data terminal Ready
5	GND		
6	DSR	Input	Data Set Ready
7	RTS	Output	Request To Send
8	CTS	Input	Clear To Send
9	GND		

PC

Signal	Pin No.
FG	1
TXD	3
RXD	2
RTS	7
CTS	8
	6
GND	5
DTR	4



## 2. Selecting the RS-232C Baud Rate

The RS-232C baud rate can be changed according to the setting made on the computer that is used for remote measurement.

### [Operating Procedure]

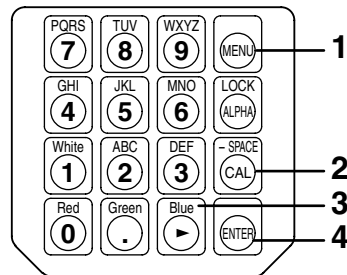

1. Press the key.  
The LCD display section will switch to the menu selection screen.
2. Press the key to open the RS232C baud rate selection screen.  
Each time the key is pressed, the screen will switch in the order PROBE → SYNC → ID Name input → RANGE → Measurement Speed → Number of Digits → Calibration Standard → RS232C Baud Rate → PROBE.
3. Press the key until the desired baud rate appears.  
Each time the key is pressed, the baud rate switches in the order 38400 → 19200 → 9600 → 4800 → 2400 → 1200 → 600 → 300 → 38400.
4. Press the key to confirm the selection.

Menu selection screen

```
MENU : SELECT
PUSH SPACE KEY
```

RS-232C baud rate selection screen

```
SELECT : BAUD
38400
```

```
SELECT : BAUD
19200
```

```
SELECT : BAUD
9600
```

Press the key until the desired baud rate appears.

\* By default (factory setting), the instrument is set so that [38400] will be selected automatically when the POWER switch is set to ON(I).

\* To cancel selection of RS-232C baud rate, press the key.

### <Notes when Selecting the RS-232C Baud Rate>

- The specified RS-232C baud rate will be kept even if the POWER switch is set to OFF(O).  
The selected RS-232C baud rate will be effective when the POWER switch is set to ON(I).

### <Reference>

Communication parameter setting (RS-232C)

Set the same communications settings as those on the instrument to the computer.

Baud rate: 38400 (factory setting), 19200, 9600, 4800, 2400, 1200, 600, 300, BPS

Start bit: 1 bit

Character length: 7 bits (ASCII code)

Parity check: EVEN

Stop bit: 2 bits

## 3. Communicating with PC via USB

The USB cable can be connected/disconnected even if the power to the instrument is ON. However, in this manual, the power must be turned OFF before connecting the USB cable.

### [Connecting Method]

1. Set the **POWER** switch to **OFF(O)**.
2. Connect the **USB** cable to the **USB** port on the instrument.
3. Check that the **USB** cable's plug is fully inserted and connected firmly.

- Use the USB cable of 2m or less.
- When disconnecting the USB cable, pull it by holding the plug. Never pull the cable by its cord.
- Pay attention to the shape of the USB cable's plug and make sure that the correct USB plug is connected to the USB port on the instrument.
- If the computer has two or more USB ports, the USB cable can be connected to any of them.
- When it uses at the same time with other machines, it doesn't sometimes work normally.

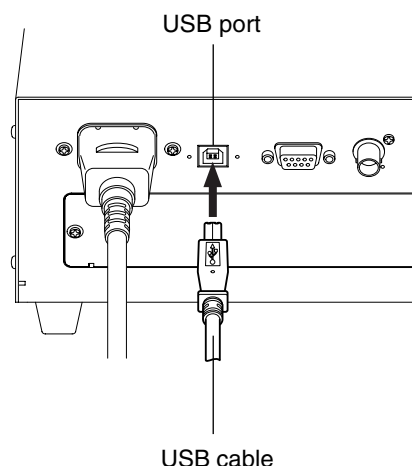

### <Notes on Communication via USB>

- One computer cannot control more than two instruments (i.e. only one instrument can be controlled by one computer).
- If you want to control more than two instruments from one computer, connect them via RS-232C. It is not possible for one computer to control one instrument via USB and another instrument via RS-232C.

## 4. Remote Measurement

In remote measurement mode, the instrument is controlled from the computer.

### [Operating Procedure]

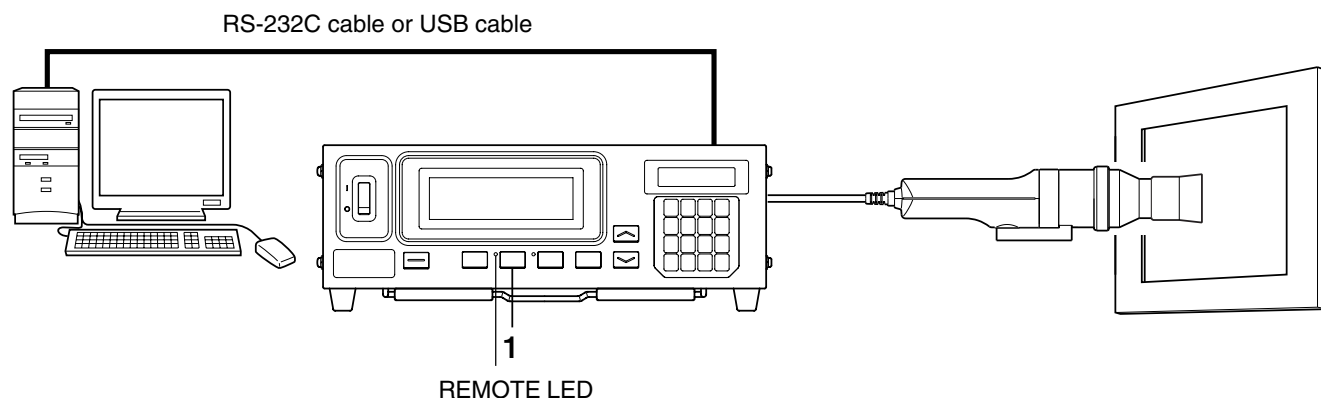

1. Press the **REMOTE** key.

The REMOTE LED will light up, indicating the instrument is ready for remote measurement (i.e. ready for communication via RS-232C or USB).

# Explanation Section

This section explains the following items.

<b>Measuring Principle</b>	Page 90
<b>Maintenance</b>	Page 101
<b>Dimension Diagram</b>	Page 102
<b>Error Messages</b> Please read when an error message appears in the LCD display section.	Page 103
<b>Troubleshooting Guide</b> Please read when the instrument does not function correctly.	Page 107
<b>Specifications</b>	Page 110
<b>Measurement/Quick Guide</b> Provides an outline of operations explained in the previous sections (Measurement Preparation - Settings).	Page 114

# Measuring Principle

## 1. Measuring Principle

This instrument uses sensors of a spectral sensitivity similar to the CIE 1931 color-matching function ( $\bar{x}_2\lambda$ ,  $\bar{y}\lambda$ ,  $\bar{z}\lambda$ ) to measure RGB emission energy of a color display, and displays the results in  $xyL_v$ ,  $T\Delta uvL_v$ ,  $u'v'L_v$  or XYZ values.

Measurement is performed in the following sequence.

- ① RGB emission energy of the color display is acquired through the measuring probe's receptor, and then converted to a voltage by the photoelectric conversion section. (Outputs:  $X_2$ , Y, Z)
- ② The temperature of the probe is detected by the temperature detection section. (Output: T)
- ③ The outputs ( $X_2$ , Y and Z of ①) from the photoelectric conversion section and the output (T of ②) from the temperature detection section are digitized in the A/D conversion section. A/D conversion is performed simultaneously within the measurement time according to SYNC mode.
- ④ The digitized values (counts) are sent to the instrument's CPU, where they are calculated according to the measurement mode, SYNC mode and correction factor (user calibration), which have been set using keys and switches.
- ⑤ The processing results are then displayed in the display sections, and output to a PC via RS-232C or USB.

Chromaticity coordinates (x, y) for  $xyL_v$  (CIE 1931 color space) are obtained by the following formula.

$$x = \frac{X}{X + Y + Z} \quad y = \frac{Y}{X + Y + Z}$$

X, Y and Z in the formula are tristimulus values  
( $X = X_1 + X_2 = 0.1672Z + X_2$ ).

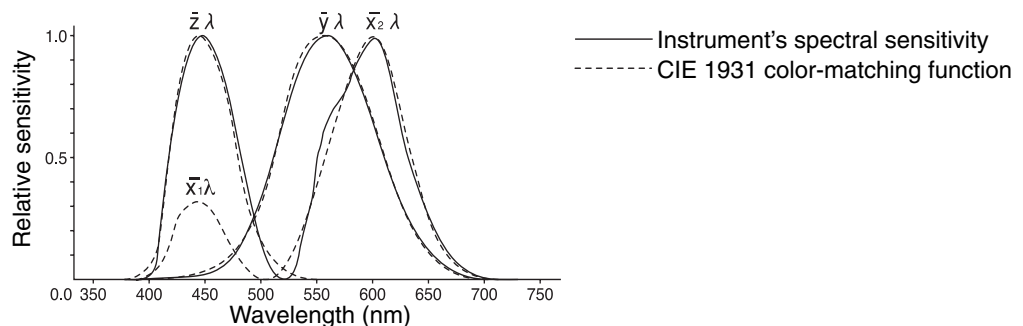

Fig. 1 Instrument's Spectral Sensitivity

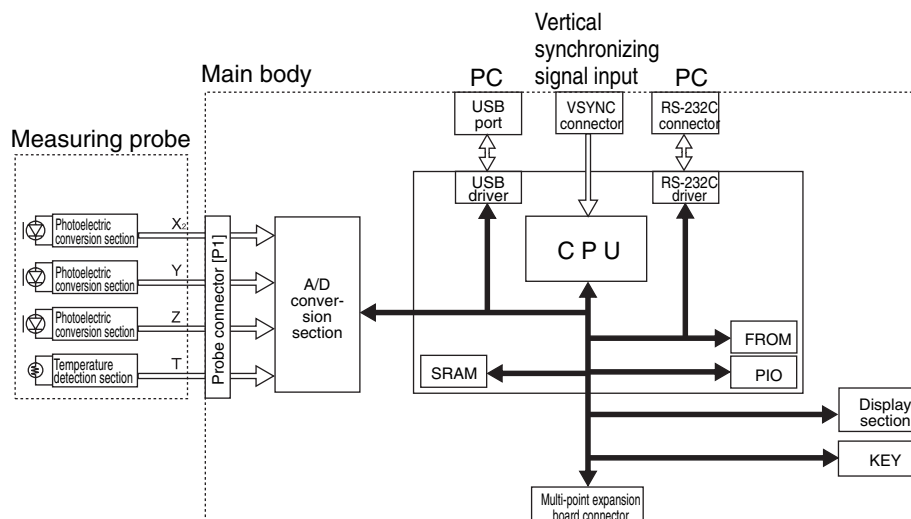

Fig. 2 Measurement Block Diagram

## 2. About T $\Delta$ uvLv

If the instrument's measurement mode is set to T $\Delta$ uvLv, the following values can be displayed in the digital display section.

- T : Correlated color temperature
- $\Delta$ uv : Color difference from the blackbody locus
- Lv : Luminance

In T $\Delta$ uvLv mode, colors are expressed in the correlated color temperature (T) and color difference from the blackbody locus ( $\Delta$ uv), and the luminance is expressed in Lv.

### <About Correlated Color Temperature T and Color Difference from Blackbody Locus $\Delta$ uv>

The temperature of a blackbody (an ideal radiator) that has the same chromaticity coordinates as that of a light is called the color temperature of that light. However, only the colors that are present along the blackbody locus can be expressed in color temperatures.

Thus, with a widened concept of color temperature, correlated color temperatures are used to express colors that are slightly off the blackbody locus.

When a color is on the isothermperature line, the color temperature at the point where that line crosses the blackbody locus is assumed to be the correlated color temperature of that color. The isothermperature line is the line that is drawn along the chromaticity coordinates of a collection of colors that you feel visually similar to color temperatures along the blackbody locus.

However, since all the colors on the same isothermperature line are expressed by the same correlated color temperature, it is not possible to express colors using correlated color temperatures only. Thus, to express colors,  $\Delta$ uv, that indicates positional relationship with the correlated color temperature T, is also used.

$\Delta$ uv is signed with “+” if the color is located above the blackbody locus, and is signed with “-” if it is below the blackbody locus.

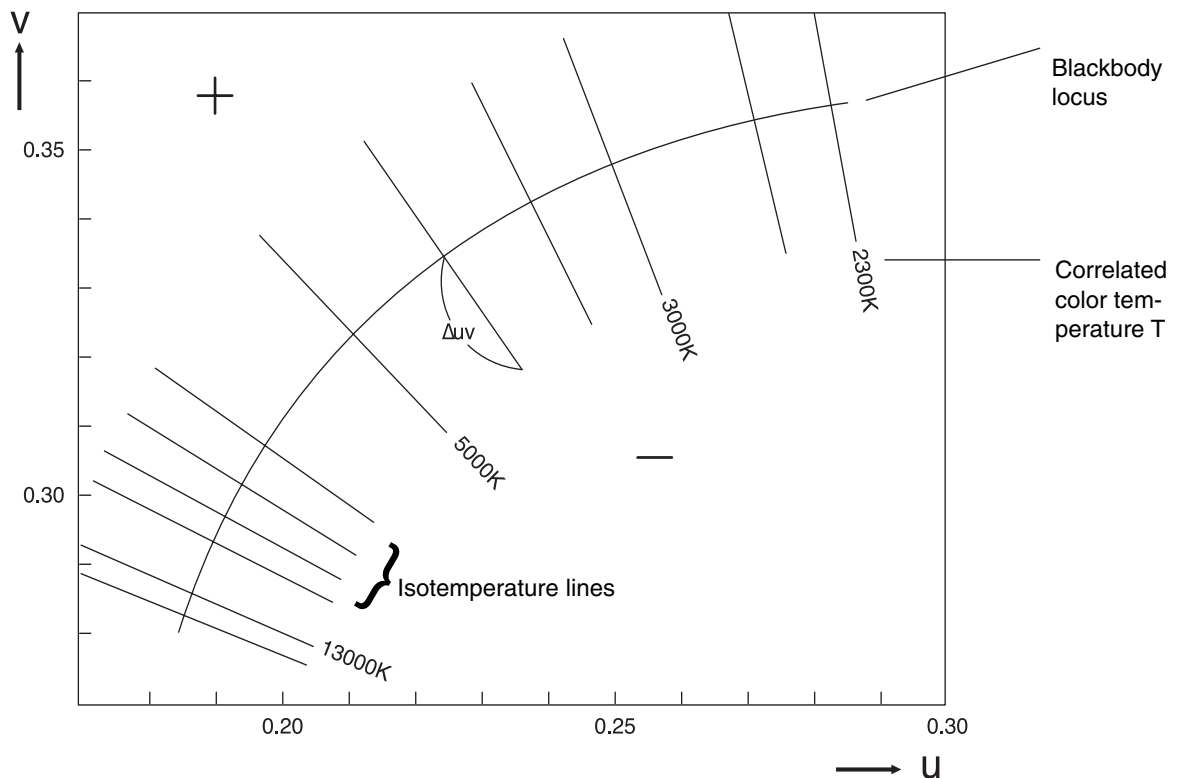

Fig. 1 Relationship between Correlated Color Temperature T and  $\Delta$ uv

### 3. Principle of User Calibration

---

This instrument uses three detectors provided in the measuring probe's receptor to measure the colors of the display.

The spectral sensitivity of these detectors does not match that of CIE 1931 color-matching function perfectly. Because of this, some colors of the display are affected by slightly shifted spectral sensitivity, resulting in the situation that absolute values of the measured values differ from the values (true values) obtained when the CIE 1931 color-matching function is used.

By performing user calibration, the influences that occur due to slight differences between the spectral sensitivity of the detectors used in the instrument and that of CIE 1931 color-matching function can be corrected when measurement is performed.

(When two or more instruments are used or when the optional 4-Probe Expansion Board CA-B14 is used to use two or more measuring probes)

Some measuring probes may have a slightly different spectral sensitivity. As a result, even if you are measuring the same display, measured values may differ from one instrument to another (difference of readings between instruments).

Such influences can be corrected by performing user calibration using the same display and the same calibration values.

This instrument allows one of the user calibration methods; white calibration (single-color calibration) or matrix calibration (RGB+W calibration).

These user calibration methods have the following features, so the user calibration that best suits your application must be selected.

#### White Calibration

User's own correction factor is set to the memory channels by measuring the white color of known values and setting the obtained calibration values (xyLv) to the instrument. Once this factor is set, the measured values will be displayed after correction by this factor and output each time measurement is taken.

Performing user calibration provides higher accuracy for measurement of colors that are close to the white color.

#### Matrix Calibration

User's own matrix correction factor is set to the memory channels by measuring three monochrome colors (R, G and B) of known values and setting the obtained calibration values (xyLv) and emission characteristic to the instrument. Once this factor is set, the measured values will be displayed after correction by this factor and output each time measurement is taken.

Performing matrix calibration enables high-accuracy measurements of displays that provide colors through additive color mixing of three monochrome colors (R, G and B).

Since the matrix correction factor obtained from Konica Minolta's calibration standard has been set, measured values calculated based on this factor will be acquired when this instrument is used for the first time since shipment from the factory.

# 4. Principle of Analyzer Mode

In analyzer mode, the emission characteristics of the display's three monochrome lights (R, G, B) and the target color are set to the instrument's memory. Once they are set, display's screen colors obtained by measurement can be converted to emission of each monochromatic light and displayed.

For instance, if emission of R among R, G and B is adjusted, only the output of R will change and the outputs of B and G will remain the same, making white balance adjustment easy (white balance measurement is performed by adjusting the output of a monochrome color).

Each sensor (spectral sensitivity:  $\bar{x}_2\lambda$ ,  $\bar{y}\lambda$ ,  $\bar{z}\lambda$ ) of the measuring probe has sensitivity towards the display's R, G and B. Thus, even if R monochrome light is emitted on the display's screen, an output will be provided from each sensor ( $\bar{x}_2\lambda$ ,  $\bar{y}\lambda$ ,  $\bar{z}\lambda$ ). This is also true in the case of G and B monochrome colors.

Therefore, to measure each of R, G and B monochrome colors independently, a certain technique is required. In this instrument's analyzer mode, measurement is performed based on the following concept.

## <About Principle of Analyzer Mode>

Fig. 1 shows measuring probe sensor's spectral sensitivity and display's R, G and B spectral distributions.

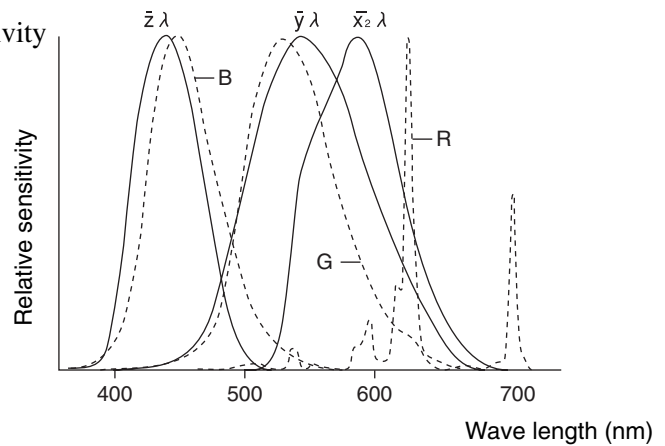

Fig. 1 Display's Spectral Distribution and Sensor's Spectral Sensitivity

The outputs of sensors  $\bar{x}_2\lambda$ ,  $\bar{y}\lambda$ , and  $\bar{z}\lambda$  when only the monochrome light R is emitted are the values equivalent to the hatched areas  $X_{2R}$ ,  $Y_R$  and  $Z_R$ , respectively. Although the outputs of these sensors change according to the output of the monochrome color R, the output ratio will be constant because of the spectral characteristic of the display and sensors.

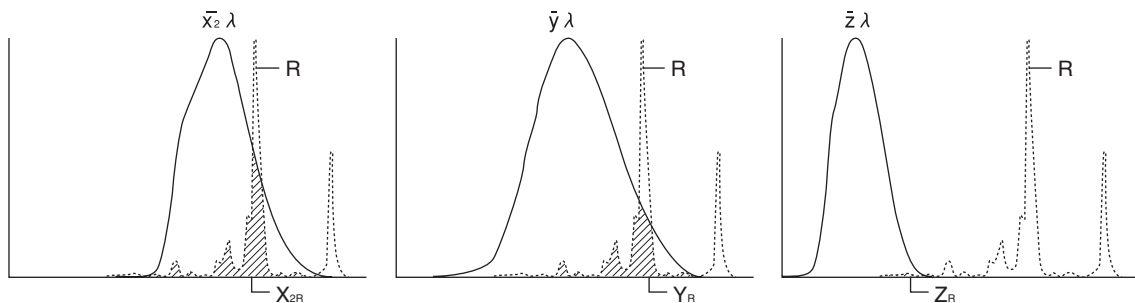
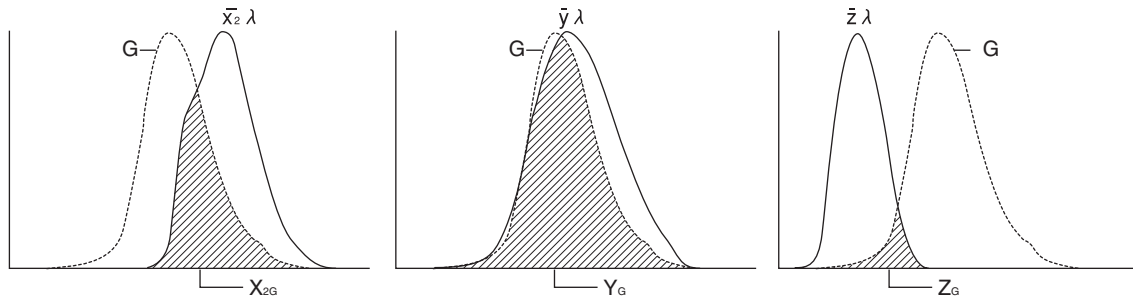
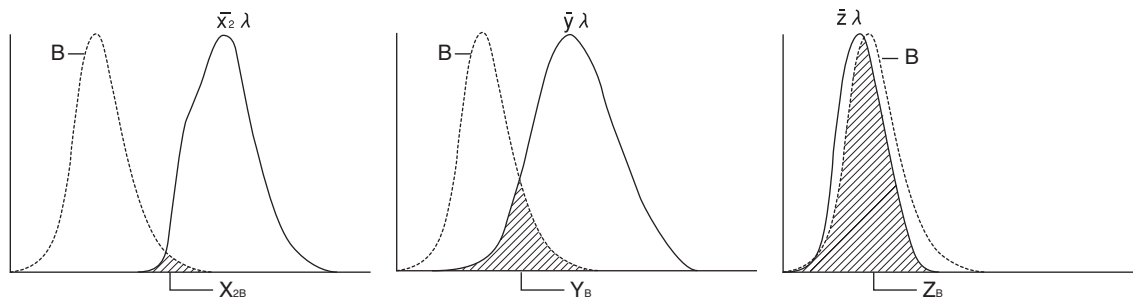

Fig. 2 Outputs of Sensors  $\bar{x}_2\lambda$ ,  $\bar{y}\lambda$ , and  $\bar{z}\lambda$  by Emitted Monochrome Light R

The above also applies when only monochrome light G is emitted as well as when only monochrome light B is emitted, and the outputs are shown in Figs. 3 and 4, respectively.



**Fig. 3 Outputs of Sensors  $\bar{x}_2\lambda$ ,  $\bar{y}\lambda$ , and  $\bar{z}\lambda$  by Emitted Monochrome Light G**



**Fig. 4 Outputs of Sensors  $\bar{x}_2\lambda$ ,  $\bar{y}\lambda$ , and  $\bar{z}\lambda$  by Emitted Monochrome Light B**

By emitting each monochrome light alone and setting the output ratio of each sensor as a constant (correction factor) to the memory, the output of each monochrome light (R, G, B) can be calculated based on the output of each sensor, even when three colors are emitted by the display at the same time.

R, G and B are displayed in percentage (%) to each monochrome light of the target color (W), being 100.

Therefore, before performing measurement in analyzer mode, the display's emission characteristic and target color (W) must always be set to the instrument's memory.

In addition, for measurement in analyzer mode, the memory channel to which the same emission characteristic and target color (W) as those for the display to be measured were set must be used.



## 5. Optical System of CA-210 Probe

The optical system consists of an objective lens and optical fiber.

Among the lights emitted from the LCD under measurement, only the lights that are emitted at within  $\pm 2.5$  degrees (Small Universal Measuring Probe(CA-PSU12/15) and Small LCD Flicker Measuring Probe(CA-PS12/15) :  $\pm 5$  degrees) perpendicular to the LCD are guided by the objective lens to the fiber. After being input to the fiber, the lights are divided into three portions, and each portion is received by a sensor that has a spectral sensitivity similar to the CIE 1931 color-matching function. (Three sensors in total).

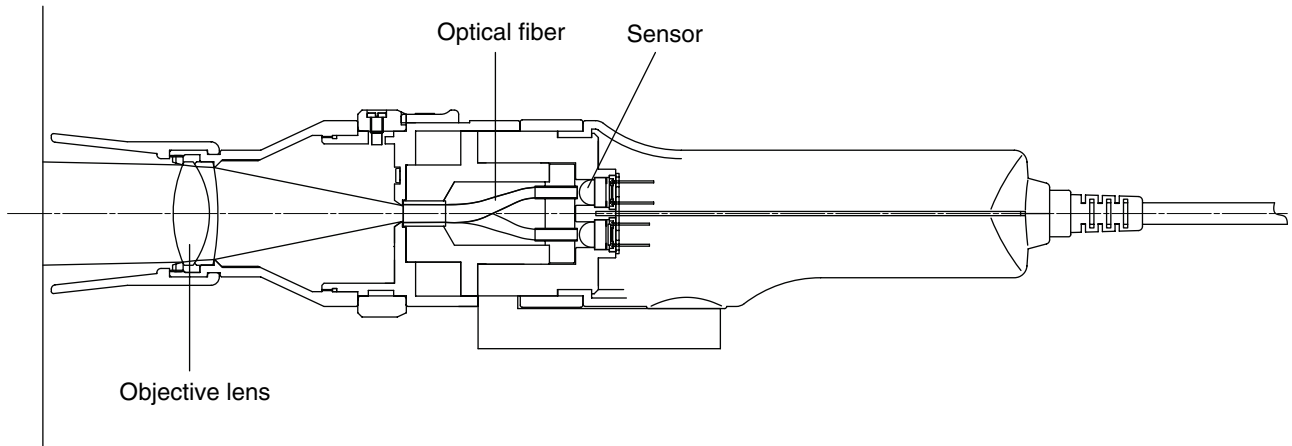

IEC 61747-6 stipulates the following measuring requirements for LCD evaluation methods.

- Light receiving angle must be within 5 degrees.
- The measuring area must consist of 500 pixels or more.

Measuring probe satisfies the above requirements since it employs an optical system that receives only the lights emitted within  $\pm 2.5$  degrees from a relatively wide measuring area ( $\phi 27$ ).

(Small Universal Measuring Probe(CA-PSU12/15) and Small LCD Flicker Measuring Probe(CA-PS12/15), within  $\pm 5$  degrees from a small measuring area( $\phi 10$ ).)

## 6. Principle of Flicker Mode

### <What is Flicker?>

“Blinking“ that appears on the display under certain conditions is called flicker.

This symptom occurs when settings like refresh rate and resolution do not match those set on the display, and in the case of LCD, it may also occur depending on the displayed colors.

Since flicker occurs periodically, it has an adverse effect on the user’s eyes.

The relationship between the time axis (horizontal) and intensity level (vertical axis) is shown in Fig. 1.

From this, it is obvious that the intensity level changes periodically and the larger its amplitude the more clearly the flicker is recognized.

In addition, it is known that the frequency of intensity level change is twice as large as that of the display’s vertical synchronizing signal.

### <Flicker Measurement Method>

Two kinds of quantifying measurement methods are available: contrast method and JEITA method.

With the CA-210 with LCD Flicker Measuring Probe(CA-P12/15) or Small LCD Flicker Measuring Probe(CA-PS12/15) alone, the contrast method is possible. Use of the software supplied with the instrument also allows JEITA method.

This section gives an outline of both quantifying measurement methods.

#### (1) Contrast Method

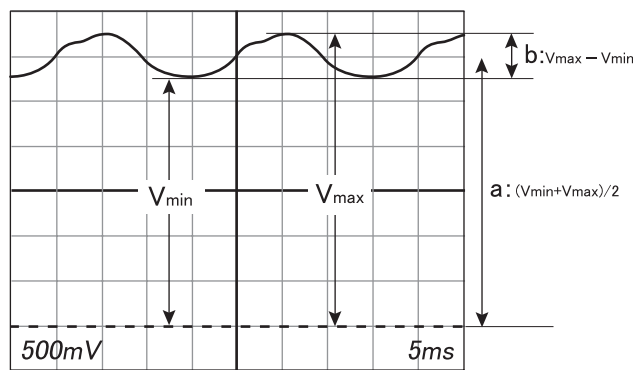

Fig. 1

If the intensity level of the display changes as Fig. 1, it is considered that AC component (b) overlaps on the DC component (a). With the contrast method, the ratio of AC component to DC component is defined as the flicker amount.

AC component (a) is defined as  $V_{max} - V_{min}$  and DC component (b) as  $(V_{max} + V_{min})/2$ , and the flicker amount is calculated by the following formula.

$$\begin{aligned} \text{Flicker amount} &= \text{AC component} / \text{DC component} \\ &= (V_{max} - V_{min}) / \{(V_{max} + V_{min})/2\} \times 100 [\%] \end{aligned}$$

**(2) JEITA Method**

With the contrast method, the amount of flicker does not depend on its frequency, and is calculated based on the AC and DC components of the measured luminance.

However, human sensitivity to flickering starts to drop gradually at about 30 Hz, and when the frequency exceeds 60 Hz, it is no longer possible for humans to sense it.

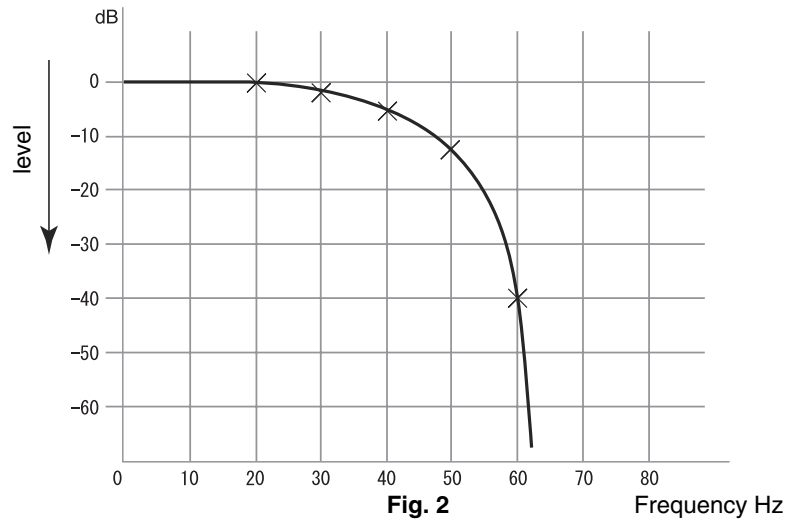

From this, it is possible that even if a flicker of a large amplitude and frequency of 60 Hz or higher exists the human eye cannot recognize it as a flicker.

Thus, with the JEITA method of flicker measurement, it is very important to know the exact amplitude and frequency of flicker energy, in addition to the AC /DC component ratio, that is defined by the contrast method.

With the JEITA method, the measuring devices shown below are required for measurement.

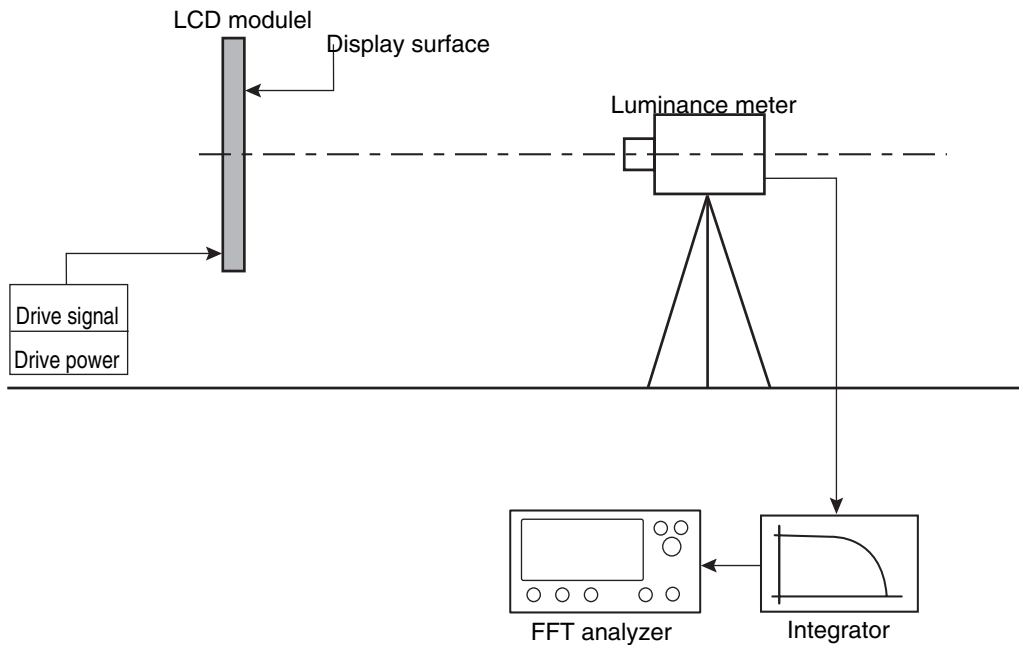
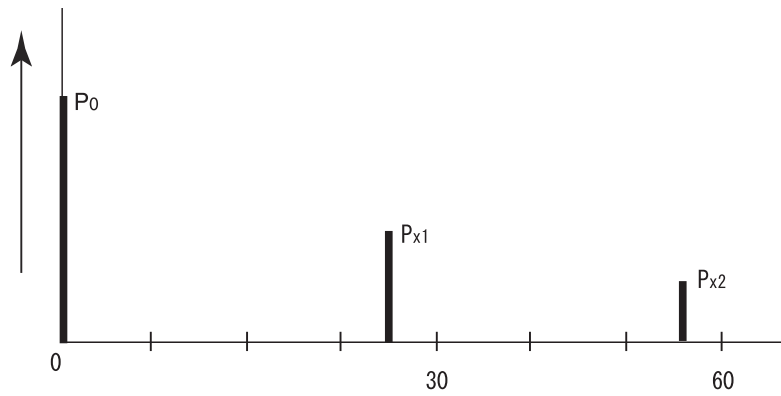

**Fig. 3**

Fig. 3 shows that the output signal (Fig. 1) from the luminance meter (used to measure the LCD) is guided to the integrator.

To reconstruct what is seen by the human eye, the integrator sends the signal through a filter that decreases the sensitivity because of frequency difference, and then outputs it to the FFT analyzer.

The signal is processed by the FFT analyzer (Fast Fourier Transform Analyzer), and is displayed in a form of energy distribution of frequency components (Fig. 4).



As shown in Fig. 4, when two or more frequency components ( $P_0$ ,  $P_{x1}$ ,  $P_{x2}$ ) exist, the maximum value among all the frequency components ( $P_{x1}$ ,  $P_{x2}$  in the case of Fig. 4) except for  $P_0$ , that is the component of frequency 0, will be set as  $P_x$ . With the JEITA method, the flicker amount in this example is calculated by the following formula.

$$\text{Flicker amount} = 10 \times \log (P_x/P_0) \text{ [dB]}$$

<Emission intensity fluctuation of displays and "Flicker" measuring function of the CA-210>

**Emission characteristics of different displays**

Fig. 5-1 to 5-3 is the figure of emission characteristics of popular displays.

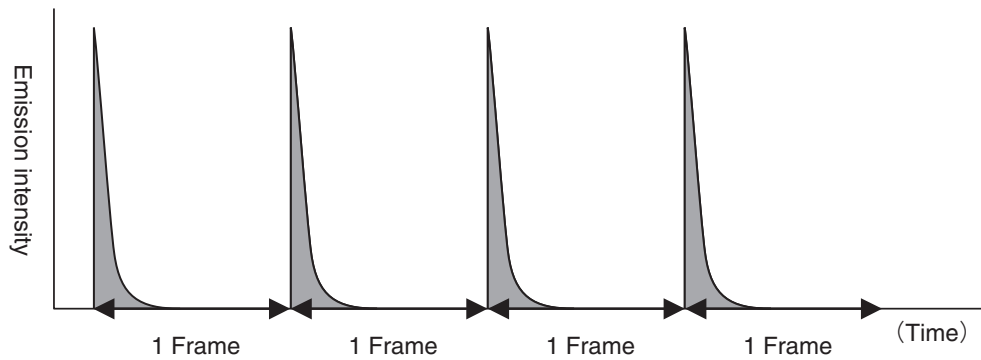

**Fig. 5-1 Emission characteristics of CRT**

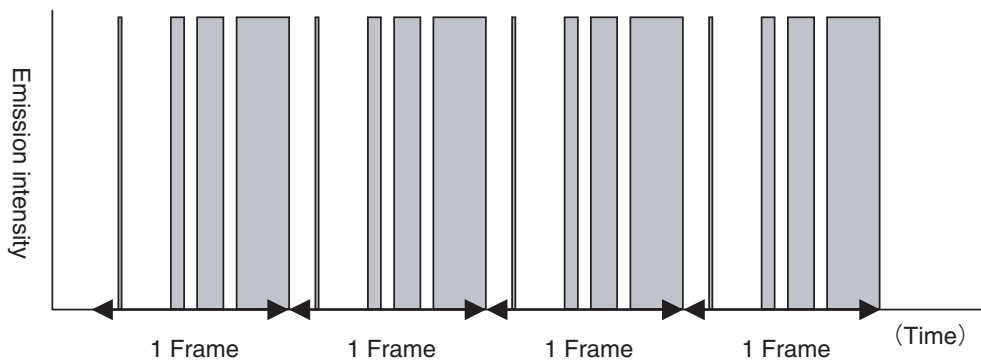

**Fig. 5-2. Emission Characteristics of PDP**

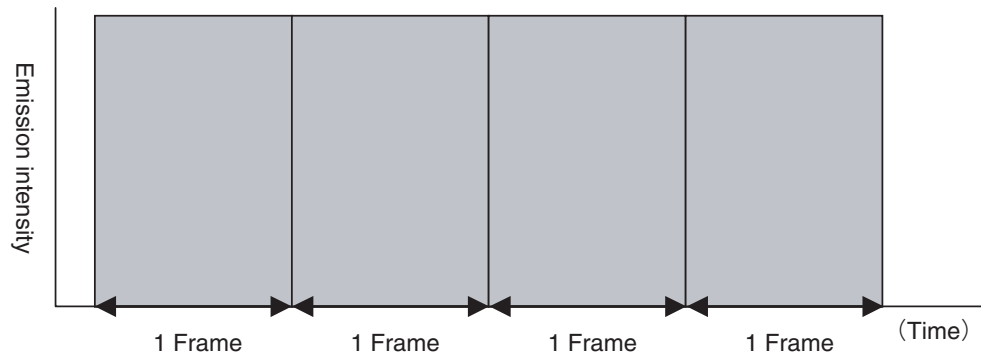

**Fig. 5-3 Emission Characteristics of Active matrix LCD**

As shown in the Fig. 5-1, emission intensity of CRT fluctuates in a scanning period of the single frame. CRT emits light when electronic beam hits phosphor by scanning the screen. But the electronic beam hits the phosphor only for a moment and phosphor emits maximum light at that time and decreases the intensity gradually. So the emission intensity repeats this variation in a frame.

The reason of the variation is different by type of the display and the intensity of the PDP also fluctuates in the single frame period. On the other hand, the intensity of the active matrix LCD is stable in the single frame as shown in the Fig. 5-3.

**<Applicable model of the CA-210 vs. display types>**

The CA-210 with Universal Measuring Probe(CA-PU12/15) or Small Universal Measuring Probe(CA-PSU12/15) can measure the display devices whose intensity fluctuates such as CRT or PDP. On the other hand, when using LCD Flicker Measuring Probe(CA-P12/15) or Small LCD Flicker Measuring Probe(CA-PS12/15) the CA-210 is limited to be used only for measuring displays whose intensity does not vary in a frame scanning period as shown in Fig. 5-3. So inaccurate measurement data is sometimes obtained for CRT or PDP with the CA-P12/15 or CA-PS12/15.

The emission intensity of some types of LCD fluctuates in a scanning period of the single frame. In this case, inaccurate measurement data is sometimes obtained for even the active matrix LCD with the CA-P12/15 or CA-PS12/15. Please contact Konica Minolta for more information.

**<"Flicker" measuring function of the CA-210>**



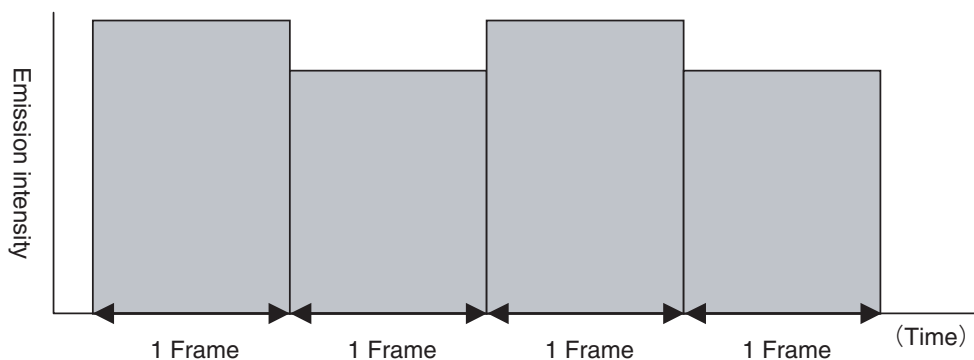









Followings explain how the CA-210 measures "Flicker". When the "Flicker" happens to active matrix LCD that is stable during single frame scanning period (see Fig. 5-3.), the emission status is as shown in Fig. 6. When the intensity fluctuates by each frame, human eyes notice it as flicker. "Flicker measuring function of the CA-210 quantifies the amount of this fluctuation. Since the display perception becomes very bad with "Flicker", it is adjusted to minimum in the LCD manufacturing process.



**Fig. 6 Emission status of LCD with "Flicker"**

Note : The emission of CRT or PDP fluctuates in a frame and such light is called "flickering light" among the display industry. This "flickering light" and the "Flicker" which is measured by the CA-210 are two different things.

# Maintenance

 <b>SAFETY WARNING</b> (Failure to adhere to the following points may result in death or serious injury.)	
 <p>If you are not going to use the instrument for a long time, disconnect the AC power cord from the AC outlet. Dirt or water may accumulate on the prongs of the AC power cord's plug and it may cause a fire. If there is any dirt or water on the prongs, it must be removed.</p>	 <ul style="list-style-type: none"> <li>• Take special care not to allow liquid or metal objects to enter the instrument.</li> </ul>
 <p>Do not disassemble or modify the instrument. Doing so may cause a fire or electric shock.</p>	 <ul style="list-style-type: none"> <li>• Should liquid or metal objects enter the instrument, turn the power OFF immediately, disconnect the AC cord from the AC outlet, and contact the nearest Konica Minolta authorized service facility.</li> </ul>
	 <p>Failure to observe this may cause a fire or electric shock.</p>
	 <ul style="list-style-type: none"> <li>• The instrument should not be used if it is damaged, or if smoke or odd smells occur.</li> </ul>
	 <ul style="list-style-type: none"> <li>• If smoke or odd smells occur or if the instrument is damaged, turn the power OFF immediately, disconnect the AC cord from the AC outlet, and contact the nearest Konica Minolta authorized service facility.</li> </ul>
	 <p>Failure to observe this may result in a fire.</p>

## 1. Cleaning the Instrument

- If the instrument gets dirty, wipe it with a soft dry cloth. Never use solvents such as thinner and benzene.
- If the measuring probe receptor's objective lens gets dirty, wipe it with a soft dry cloth or lens cleaning paper.
- Should the instrument break down, do not try to disassemble it by yourself. Contact a Konica Minolta authorized service facility.

## 2. Storing the Instrument

- The instrument and its optional accessories should be stored within the following temperature range. Do not store them in areas subject to high temperatures and high humidity. For added safety, it is recommended that they be stored with a drying agent (such as silica gel) at near room temperature.
  - Main body and measuring probes ] -20 to 55 °C
  - 4-Probe Expansion Board CA-B14 ]
- Take care not to allow condensation to form on the instrument during use. When moving the instrument to the location where it is to be used, take care not to expose it to temperature changes.
- When storing the optional 4-Probe Expansion Board CA-B14, always put it in the anti-static bag in which the board is supplied.

# Dimension Diagram

## <Main Body>

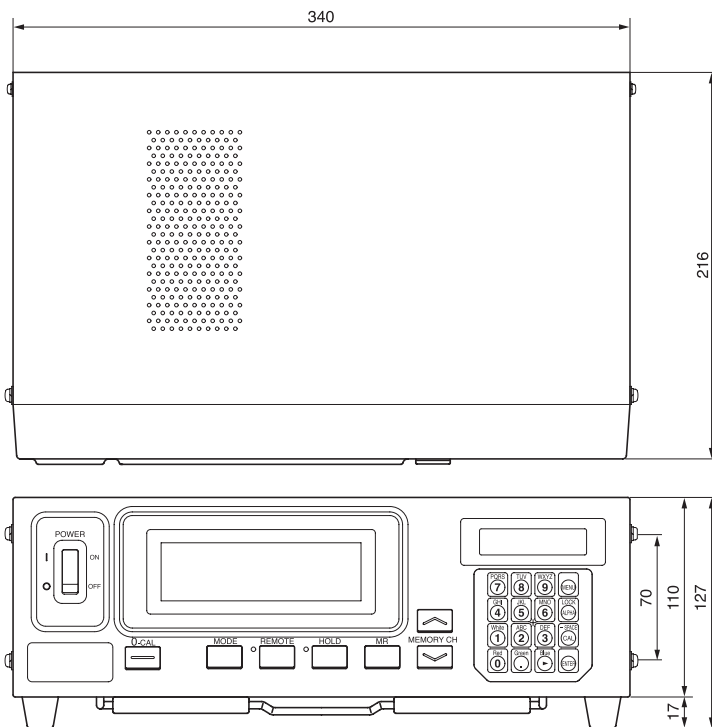

(Unit : mm)

## <Universal Measuring Probe (CA-PU12 / CA-PU15) > <LCD Flicker Measuring Probe (CA-P12 / CA-P15) >

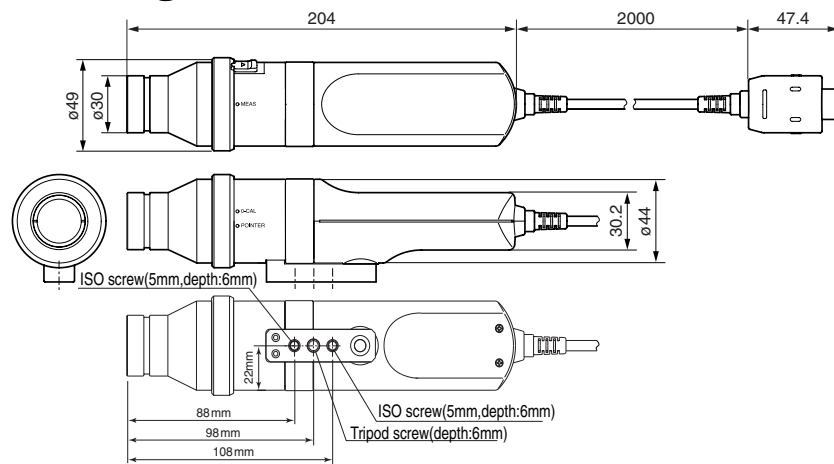

## <Small Universal Measuring Probe (CA-PSU12 / CA-PSU15) > <Small LCD Flicker Measuring Probe (CA-PS12 / CA-PS15) >

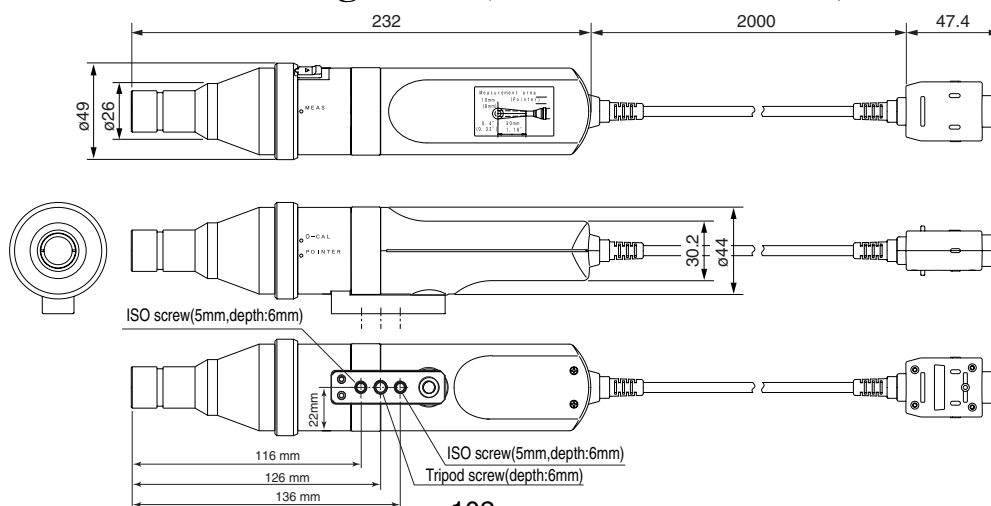



# Error Messages

The following error messages appear if the instrument does not operate correctly.

The table below shows kinds of error message, their meanings (description) and corrective actions.

Error Message	Cause: (Description)	Corrective Action
*1 *2 E1 CH01 NTSC Ad P1 E1 [ ]	<ul style="list-style-type: none"> <li>When xyLv, TΔuvLv, u'v'Lv, or XYZ measurement mode is selected               <ol style="list-style-type: none"> <li>No target color has been set to the memory channel since shipment from factory.</li> <li>The currently used measuring probe is different from the one used to perform user calibration and set the target color.</li> </ol> </li> <li>When analyzer measurement mode (RGB) is selected               <ol style="list-style-type: none"> <li>The RGB emission characteristic for analyzer mode has not been input for the selected memory channel since shipment from factory.</li> <li>The currently used measuring probe is different from the one used to input the RGB emission characteristic for display's analyzer mode and set the target color (W).</li> </ol> </li> <li>The settings made to the selected memory channel have been lost.</li> </ul>	<ol style="list-style-type: none"> <li>Perform user calibration or set the target color.</li> <li>Use the same probe as the one used to perform user calibration and set the target color. (Page 26) Or set the target color using the currently used probe. (If you press the <b>MR</b> key for two to four seconds while a menu is displayed on the LCD, the upper line will show the user calibration/emission characteristic, and the lower line shows the probe no. used to set the target color. However, in the case of xyLv, TΔuvLv, u'v'Lv or XYZ mode, the upper line shows the probe no. that was used to perform user calibration. In the case of analyzer mode, it shows the probe no. that was used to input the RGB emission characteristic for analyzer mode. In flicker mode, both upper and lower lines show "00000000".)</li> <li>Input the RGB emission characteristic for display's analyzer mode.</li> <li>Perform corrective action 2 given in . *3*4</li> </ol> <ul style="list-style-type: none"> <li>Make them again.</li> </ul>
*2 E2 CH01 NTSC Ad P1 E2 [ ]	<ul style="list-style-type: none"> <li>An error has occurred due to shift of the zero point because the ambient temperature has changed since zero calibration.</li> </ul>	<ul style="list-style-type: none"> <li>Perform zero calibration. (Page 34) (Measurement can still be performed even if "E2" is currently displayed.)</li> </ul>
E3 E3 x y Lv P1 3300 0000 39.50	<ul style="list-style-type: none"> <li>An attempt was made to set an incorrect value when performing user calibration or setting the target color to CH00 by entering its values directly. Incorrect calibration values mean the following.               <ol style="list-style-type: none"> <li>One of x, y and Lv is "0".</li> <li><math>1 - x - y \leq 0</math></li> <li>Values which are beyond the instrument's calculation capability or other contradicting values</li> </ol> </li> </ul>	<ul style="list-style-type: none"> <li>Enter correct values and then press the <b>ENTER</b> key.</li> </ul>
E4 RANGE x,y Lv E4(%) 0.0 2.0	<ul style="list-style-type: none"> <li>"0%" was set when setting the analog display range.</li> </ul>	<ul style="list-style-type: none"> <li>Enter a correct value and then press the <b>ENTER</b> key. The settable range is from 0.1 to 99%. (Page 69)</li> </ul>
E5 CH01 U-CAL E5 *W *R G *B	<ul style="list-style-type: none"> <li>No entry has been made for one of W, R, G and B.</li> <li>The <b>White</b> key was pressed when the measuring range for target color (W) was exceeded.</li> </ul>	<ul style="list-style-type: none"> <li>Enter values for the color for which no values have been made, and then press the <b>ENTER</b> key. (Page 54 or 59)</li> <li>Enter values for the color for which no Input the target color values (W) that are within the measuring range, and press the <b>ENTER</b> key.</li> </ul>
E6 CH01 U-CAL E6 *W *R *G *B	<ul style="list-style-type: none"> <li>An attempt was made to set an incorrect value when performing matrix calibration.</li> </ul>	<ul style="list-style-type: none"> <li>Enter correct values and then press the <b>ENTER</b> key.</li> </ul>
E7 SELECT : SYNC. E7 INT000.0Hz	<ul style="list-style-type: none"> <li>Although INT SYNC mode is selected, the setup value isn't correct.</li> </ul>	<ul style="list-style-type: none"> <li>Set the correct value, the correct value is value between 40-200 Hz.</li> </ul>

(Note) • \*1: If "E1" appears, the cause of the error can be located easily by checking the serial no. of the probe used to make settings and the current probe serial no. For details, refer to page 106.



• \*2: "E2" will not appear if "E1" is currently displayed.

	<b>Error Message</b>	<b>Cause: (Description)</b>	<b>Corrective Action</b>
*3 *4	OFFSET ERROR OFFSET ERROR PUSH 0-CAL KEY	<ul style="list-style-type: none"> <li>Zero calibration has not been performed correctly. (Zero calibration was performed with insufficient blocking of entry of light.)</li> <li>Pressure is given to probe.</li> <li>It is sometimes indicated under the condition that the switching ring is set on "POINTER".</li> </ul>	<ul style="list-style-type: none"> <li>Perform zero calibration again. (Page 34) (Even if the error message is currently displayed, measurement will start if the measuring probe's receptor is exposed to light.)</li> <li>Don't give the pressure.</li> <li>This is not a trouble.</li> </ul>
	TOO BRIGHT TOO BRIGHT	<ul style="list-style-type: none"> <li>Zero calibration is being performed with insufficient blocking of entry of light.</li> </ul>	<ul style="list-style-type: none"> <li>Block the light completely for all the measuring probes, and when "DARKEN PROBE PUSH 0-CAL KEY" appears press the [0-CAL] key again. (Page 34)</li> </ul>
*3 *5	NO SYNC. SIGNAL NO SYNC. SIGNAL	<ul style="list-style-type: none"> <li>Although EXT SYNC mode is selected, the vertical synchronizing signal used for the display is not input correctly to the terminal on the instrument.</li> <li>The vertical synchronizing signal used for the display is outside the range of 40 to 200 Hz.</li> </ul>	<ul style="list-style-type: none"> <li>Input the vertical synchronizing signal correctly. (When the vertical synchronizing signal is outside the range of 40 to 200 Hz/page 28)</li> <li>Change SYNC mode to NTSC, PAL, UNIV or INT mode and start measurement.</li> </ul>
*3 *4	OVER OVER	<ul style="list-style-type: none"> <li>The measured value is exceeding the instrument's measurement range.</li> <li>The measured value is above 100,000% in analyzer mode. (Display range over)</li> </ul>	<ul style="list-style-type: none"> <li>Measurement must be performed within the measuring range.</li> </ul>
	SET MAIN PROBE SET MAIN PROBE	<ul style="list-style-type: none"> <li>The measuring probe is not connected to the probe connector [P1] properly.</li> </ul>	<ul style="list-style-type: none"> <li>Connect the probe to the probe connector [P1] properly. (Before connecting/disconnecting the measuring probe, make sure that the POWER switch is set to OFF.)</li> </ul>
	PROBE ERROR PROBE ERROR	<ul style="list-style-type: none"> <li>A measuring probe was connected or disconnected while the POWER switch was ON.</li> </ul>	<ul style="list-style-type: none"> <li>Set the POWER switch to OFF first, connect the measuring probe, then set the POWER switch to ON. (Before connecting/disconnecting the measuring probe, make sure that the POWER switch is set to OFF.)</li> </ul>
*3 *4	DATA ERROR DATA ERROR	<ul style="list-style-type: none"> <li>Measurement is not possible since the measuring circuit is not functioning correctly.</li> </ul>	<ul style="list-style-type: none"> <li>Set the POWER switch to OFF. If this error still appears even if the POWER switch is set to ON, the instrument has broken down. Contact a Konica Minolta authorized service facility.</li> </ul>
	MEMORY ERROR MEMORY ERROR	<ul style="list-style-type: none"> <li>The instrument's memory is abnormal.</li> </ul>	<ul style="list-style-type: none"> <li>Set the POWER switch to OFF. If this error still appears even if the POWER switch is set to ON, the instrument has broken down. Contact a Konica Minolta authorized service facility.</li> </ul>
	FLICKER ERROR UNDER FLICKER ERROR UNDER	<ul style="list-style-type: none"> <li>Lv is below the instrument's flicker measuring range.</li> </ul>	<ul style="list-style-type: none"> <li>Measurement must be performed within the measuring range.</li> </ul>
	FLICKER ERROR OVER FLICKER ERROR OVER	<ul style="list-style-type: none"> <li>Flicker value (contrast method) has exceeded 100.0%.</li> </ul>	<ul style="list-style-type: none"> <li>Measurement must be performed within the measuring range.</li> </ul>
	FLICKER ERROR VSYNC OVER FLICKER ERROR VSYNC OVER	<ul style="list-style-type: none"> <li>VSYNC is exceeding 130 Hz in flicker mode.</li> </ul>	<ul style="list-style-type: none"> <li>In the case of flicker mode, VSYNC of 40 to 130 Hz must be input.</li> </ul>
	FLICKER ERROR PROBE TYPE FLICKER ERROR PROBE TYPE	<ul style="list-style-type: none"> <li>A measured probe not for LCD flicker measuring is selected in Flicker Mode.</li> </ul>	<ul style="list-style-type: none"> <li>In Flicker Mode, select a measured probe for LCD flicker measuring.</li> </ul>



Error Message	Cause: (Description)	Corrective Action
<p>INCORRECT PROBE PROBE : <i>CA100Plus</i></p> <div style="border: 1px solid black; padding: 2px; width: fit-content;">INCORRECT PROBE PROBE : CA100Plus</div> <p>INCORRECT BOARD BOARD : <i>CA100Plus</i></p> <div style="border: 1px solid black; padding: 2px; width: fit-content;">INCORRECT BOARD BOARD : CA100Plus</div> <p><i>(The indication in italics shows the model name of the probe or expansion board.)</i></p>	<ul style="list-style-type: none"> <li>The connected probe or expansion board differs from the one used on the instrument.</li> </ul>	<ul style="list-style-type: none"> <li>Connect the correct probe or expansion board.</li> </ul>

(Note) • The  key is inoperable if error message \*3 is displayed.

- The instrument operates as follows if error message \*4 is displayed.

- ① Clears the display by the **MR** key.
- ② Aborts CAL ON state (i.e. the state that is effective when the  key is pressed).
- ③ Aborts MENU ON state (i.e. the state that is effective when the  key is pressed).
- ④ Aborts measuring probe selection.
- ⑤ Aborts SYNC mode selection.
- ⑥ Aborts ID name setting.
- ⑦ Aborts analog display range setting.
- ⑧ Aborts measurement speed selection.
- ⑨ Aborts selection of the number of display digits.
- ⑩ Aborts calibration standard selection.
- ⑪ Aborts RS-232C baud rate selection.

- The instrument operates as follows if the error message \*5 is displayed.

- ① The  key is inoperable during CAL ON state (i.e. the state that is effective when the  key is pressed).
- ② The **HOLD** key is inoperable.

## <Relationship Between Probe Serial No. and Error Message “E1”>

If “E1” appears, the cause of the error can be located easily by checking the serial no. of the probe used to make settings and the current probe serial no.

- Probe serial no. used for making settings : Displayed when the **MR** key is held down for two to four seconds. (The buzzer sounds once immediately after the **MR** key is pressed. It will also sound two and four seconds later if the key is kept held down. Thus, to display the probe serial no. used for making settings, release the key after the buzzer has sounded twice in total.)
- Current probe serial no. : Displayed in the PROBE selection screen when the **MR** and **CAL** keys are pressed together.

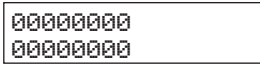
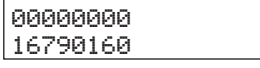
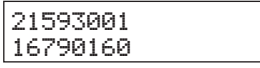
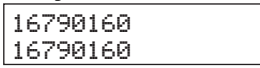
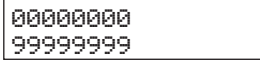
Probe Serial No. Displayed during Measurement	Cause and Action for “E1”	
	When xyLv, TΔuvLv, u'v'Lv or XYZ measurement mode is selected	When analyzer measurement mode is selected
Both lines show “00000000”. 	Cause : User calibration has not been performed or the target color has not been set for the currently selected memory channel since shipment from the factory. Action : Perform user calibration or set the target color.	Cause : Neither the RGB emission characteristic for display’s analyzer mode nor target color (W) have been set for the currently selected memory channel since shipment from the factory. Action : Set the RGB emission characteristic for the display’s analyzer mode and target color (W).
Upper line shows “00000000”. 		Cause : The RGB emission characteristic for the display’s analyzer mode has not been input. Action : Set the RGB emission characteristic for the display’s analyzer mode. If you want to set a target color different from the one that was set when the emission characteristic was set, set a new target color.
Different probe nos. 	Cause : The measuring probe used to perform user calibration is different from the one used to set the target color. Action : ① Set the target color using the measuring probe that was used for user calibration. ② Perform user calibration again using the currently connected measuring probe.	Cause : The measuring probe used to input the RGB emission characteristic for display’s analyzer mode is different from the one used to set the target color. Action : ① Set the target color using the measuring probe that was used to input the emission characteristic for the analyzer mode. ② Input the emission characteristic for the analyzer mode again using the currently connected measuring probe.
Same probe nos. 	Cause : The currently used measuring probe is different from the one that was used to perform user calibration and set the target color. Action : ① Perform measurement using the measuring probe that was used to perform user calibration and set the target color. ② Perform user calibration and set the target color .using the currently connected measuring probe.	Cause : The currently used measuring probe is different from the one used to input the RGB emission characteristic for display’s analyzer mode and set the target color. Action : ① Perform measurement using the measuring probe used to input the RGB emission characteristic and set the target color. ② Input the emission characteristic and set the target color using the currently connected measuring probe.
Upper line shows “00000000”. Lower line shows “99999999”. 	Cause : The settings made to the selected memory channel have been lost from the instrument’s memory. As a result, the default (factory) correction factor and ID name will be used instead. Action : Set them again.	Cause : The settings made to the selected memory channel have been lost from the instrument’s memory. As a result, the default (factory) ID name will be used instead. Action : Set them again.

# Troubleshooting Guide

If any of the following symptoms occur with the instrument, take the corrective actions given in the table below. If the instrument still does not operate correctly even if the necessary corrective actions are taken, the instrument might have broken down. Contact a Konica Minolta authorized service facility. When doing so, please inform them of the breakdown No.

Break-down No.	Symptom	Check Point	Action	Ref.
1	The display is blank after the POWER switch is set to ON.	Is the AC power cord connected?	Connect the AC power cord.	29
		Is the power within the specified rating? (100-240 V~, 50-60 Hz, 50VA)	Use the power that is within the rating.	26
2	Keys are inoperable.	Check whether the instrument is in remote mode (i.e. the REMOTE LED is lit).	Press the <b>REMOTE</b> key to turn off remote mode (i.e. the REMOTE LED goes out).	30
		You are maybe pressing a key that does not function.	Press the correct key.	–
		Check whether the key is in LOCK mode.	Hold down the  key (for two seconds) to cancel LOCK mode.	18
3	Zero calibration does not end. ("ZERO CALIBRATION" is displayed in the LCD display section.) "TOO BRIGHT" is displayed even if the light is blocked properly.		Turn the power OFF, turn it ON again, and then perform zero calibration. If this symptom still occurs, the instrument is broken down.	29 35
4	"NO SYNC. SIGNAL" is displayed in EXT SYNC mode.	Is the cable for the vertical synchronizing signal connected to the terminal on the instrument and is the vertical synchronizing signal input?	Connect the cable to the connector on the instrument and display, and input the vertical synchronizing signal.	28
		Does the level of the vertical synchronizing signal conform to the specified input condition?	Set the signal level so that it conforms to the specified input condition.	28
		If the frequency is 130 to 200 Hz in the case of flicker mode, the error message "FLICKER ERROR VSYNC OVER" will appear. (Page 102)	Make sure that the frequency is within the following range. Color measurement 40 to 200 Hz Flicker measurement 40 to 130 Hz	38
5	The calibration values entered for user calibration using keys differ from those displayed at the end of calibration.	Is Lv of the calibration values for low luminance?	If a low-luminance value is used as the calibration value, this symptom may occur due to calculation error.	50
6	Measurement results fluctuate.	Is an appropriate SYNC mode selected for the display measured?	Select an appropriate SYNC mode and perform measurement.	38
		You are maybe measuring a low-luminance display.	Repeatability for x and y drops if a low-luminance display is measured.	76
		Is the measuring probe placed with the display and secured firmly?	Make sure that the probe is placed with the display and secured firmly.	76 13
		Is "4-Probe Expansion Board CA-B14" fixed by the screw?	Fix it with the screw securely.	27
		Is the AC power code connected to protective grounding terminal properly?	Be sure to connect the AC power cord's plug to an AC outlet that has a protective grounding terminal.	28

Break-down No.	Symptom	Check Point	Action	Ref.
7	Odd measured values are displayed.	Is the receptor of the measuring probe clean?	If it is dirty, wipe it with a soft dry cloth or lens cleaning paper.	107
		Is the ambient temperature stable?	If the ambient temperature has changed, perform zero calibration.	34
		Was user calibration performed correctly?	Perform user calibration again.	50
8	Analog display does not change.	Is the analog display range correct?	Set the correct range.	68
		Was the target color set correctly?	Set the correct target color. (Perform user calibration, set the RGB emission characteristic for the display's analyzer mode or set/change the target color correctly.)	50 58 61
9	<b>During communication with RS-232C</b>	Are the instrument (RS-232C connector) and PC connected with a RS-232C cable properly?	Connect them properly.	84
	Data output from the instrument cannot be imported to PC.	Is pin assignment of the RS-232C cable correct?	A RS-232C cable with correct pin assignment must be used.	84
		Is the correct RS-232C baud rate set?	Make sure that the RS-232C baud rate set on PC matches that on the instrument.	85
	Commands or data cannot be input from PC to the instrument.	Check whether the instrument is in remote OFF mode (i.e. the REMOTE LED is not lit).	Press the <b>REMOTE</b> key to turn ON remote mode (i.e. the REMOTE LED lights up).	86
		Is the created program correct?	Check it by referring to a sample program.	–
10	<b>During communication with USB</b>	Are the instrument (USB port) and PC connected with a USB cable properly?	Connect them properly.	86
	Data output from the instrument cannot be imported to PC.	Is pin assignment of the USB cable correct?	A USB cable with correct pin assignment must be used.	86
		Check whether the instrument is in remote OFF mode (i.e. the REMOTE LED is not lit).	Press the <b>REMOTE</b> key to turn ON remote mode (i.e. the REMOTE LED lights up).	86
	Commands or data cannot be input from PC to the instrument.	Is the created program correct?	Check it by referring to a sample program.	–
11	“DATE ERROR” is displayed continuously in the LCD display section.		Turn the power OFF, and then turn it ON again. If this symptom still occurs, the instrument has broken down.	29
12	“MEMORY ERROR” is displayed in the LCD display section.		Turn the power OFF, and then turn it ON again. If this symptom still occurs, the instrument has broken down.	29

**When the optional 4-Probe Expansion Board CA-B14 is used**

<b>Break-down No.</b>	<b>Symptom</b>	<b>Check Point</b>	<b>Action</b>	<b>Ref.</b>
13	Probes P2 to P5 cannot be selected. (cannot be displayed in the LCD display section)	Is the 4-Probe Expansion Board installed correctly?	Install it correctly.	27
		Are the measuring probes connected to the probe connectors [P2] to [P5] properly?	Connect necessary number of probes to the probe connectors properly.	26 27
14	Probe cannot be changed. (cannot be displayed in the LCD display section)	Do you want to select Universal Measuring Probe(CA-PU12/15) or Small Universal Measuring Probe(CA-PSU12/15) when the measurement mode is Flicker Mode?	Select the measurement mode other than Flicker Mode.	43

# Specifications

Item	CA-210(Universal Measuring Probe)		
Receptor	Detector: Silicon photo cell		
Measurement area	φ27 mm		
Acceptance angle	±2.5°		
Pointing function	By LED		
Measurement distance	30±10 mm		
Display range	Luminance	0.01 to 1000 cd/m <sup>2</sup>	
	Chromaticity	Displayed in 4 or 3-digit value (Can be chosen)	
Luminance	Measurement range	0.10 to 1000 cd/m <sup>2</sup>	
	Accuracy(for white)*1	±2 %±1 digit of reading(temperature:23°C±2°C, relative humidity:(40±10) %)	
	Repeatability*1	0.10 to 0.99 cd/m <sup>2</sup>	0.2 %±1 digit (2 σ)
1.00 to 1000 cd/m <sup>2</sup>		0.1 %±1 digit (2 σ)	
Chromaticity	Measurement range	0.10 to 1000 cd/m <sup>2</sup>	
	Accuracy*1	0.10 to 4.99 cd/m <sup>2</sup>	±0.008 for white (temperature:23°C±2°C, relative humidity:(40±10) %)
		5.00 to 39.99 cd/m <sup>2</sup>	±0.005 for white
		40.00 to 1000 cd/m <sup>2</sup>	±0.003 for white
		120 cd/m <sup>2</sup>	±0.002 for white (±0.004 for monochrome)*2
Repeatability*1	0.10 to 0.19 cd/m <sup>2</sup>	0.015 (2 σ)	
	0.20 to 0.49 cd/m <sup>2</sup>	0.008 (2 σ)	
	0.50 to 1.99 cd/m <sup>2</sup>	0.003 (2 σ)	
	2.00 to 1000 cd/m <sup>2</sup>	0.001 (2 σ)	
Measurement speed*3	xyLv	0.10 to 3.99 cd/m <sup>2</sup> 5 measurements/sec. (4.5 measurements/sec.)	
		4.00 cd/m <sup>2</sup> or higher 20 measurements/sec. (17 measurements/sec.)	
Display	Digital	xyLv, XYZ, TΔuvLv, u'v'Lv RGB analyze Chromaticity is displayed up to fourth decimal place. (Three-digit indication can be chosen.)	
	Analog	ΔxΔyΔLv, R/G B/G ΔG, ΔR B/R G/R	
	LCD	16 characters by 2 lines (with backlight)	
SYNC mode	NTSC, PAL, EXT, UNIV, INT		
Object under measurement	Vertical synchronizing frequency: 40 to 200 Hz		
Memory channel	100 channels		
Analyzer function	Standard function		
Interface	RS-232C (38,400 bps or below), USB (1.1 conformity)		
Multi-point Measurement	Max. 5 points(Use 4-Probe Expansion Board CA-B14)		
Software	SDK software (supplied as standard accessory)		
Operating temperature/humidity range	Temperature : 10 to 28°C ; relative humidity 70 % or less with no condensation Luminance change : ±2 % ±1 digit of reading for white Chromaticity change : ±0.002 for white, ±0.006 for monochrome from reading of Konica Minolta's standard LCD, 120 cd/m <sup>2</sup> *1		
Storage temperature /humidity range	0 to 28°C ; relative humidity 70 % or less with no condensation 28 to 40°C ; relative humidity 40 % or less with no condensation		
Input voltage range	100 – 240 V~, 50–60 Hz, 50 VA		
Size	Main body: 340 (W) × 127 (H) × 216 (D) mm, Probe: φ49 × 204 mm		
Weight	Main body: 3.58 kg, Probe: 520 g		
Standard accessories	AC power cord, PC Software for Color Analyzer CA-SDK, Standard Hood CA-H10		
Optional accessories	4-Probe Expansion Board CA-B14, Universal Measuring Probe CA-PU12(2 m)CA-PU15(5 m), Standard Hood CA-H10, Standard Lens Cap CA-H11		

\*1 : The luminance and chromaticity are measured under Konica Minolta's condition (standard LCD(6500 K, 9300 K) is used).

\*2 : The luminance for monochrome is measured when the reading of luminance for white is 120 cd/m<sup>2</sup>.

\*3 : Mesuring probe connected to probe connector P1 only, USB is used(RS-232C;38,400 bps baud rate is used).

• The specifications given in this manual are subject to change without prior notice.



Item	CA-210(Small Universal Measuring Probe)		
Receptor	Detector: Silicon photo cell		
Measurement area	φ10 mm		
Acceptance angle	±5°		
Pointing function	By LED		
Measurement distance	30±5 mm		
Display range	Luminance	0.01 to 3000 cd/m <sup>2</sup>	
	Chromaticity	Displayed in 4 or 3-digit value (Can be chosen)	
Luminance	Measurement range	0.30 to 3000 cd/m <sup>2</sup>	
	Accuracy(for white)*1	±2 %±1 digit of reading(temperature:23°C±2°C, relative humidity:(40±10) %)	
	Repeatability*1	0.30 to 2.99 cd/m <sup>2</sup>	0.2%+1 digit (2 σ)
3.00 to 3000 cd/m <sup>2</sup>		0.1%+1 digit (2 σ)	
Chromaticity	Measurement range	0.30 to 3000 cd/m <sup>2</sup>	
	Accuracy*1	0.30 to 14.99 cd/m <sup>2</sup>	±0.008 for white (temperature:23°C±2°C, relative humidity:(40±10) %)
		15.00 to 119.9 cd/m <sup>2</sup>	±0.005 for white
		120.00 to 3000 cd/m <sup>2</sup>	±0.003 for white
		120 cd/m <sup>2</sup>	±0.002 for white (±0.004 for monochrome)*2
Repeatability*1	0.30 to 0.59 cd/m <sup>2</sup>	0.015 (2 σ)	
	0.60 to 1.49 cd/m <sup>2</sup>	0.008 (2 σ)	
	1.50 to 5.99 cd/m <sup>2</sup>	0.003 (2 σ)	
	6.00 to 3000 cd/m <sup>2</sup>	0.001 (2 σ)	
Measurement speed*3	xyLv	0.30 to 11.99 cd/m <sup>2</sup> 5 measurements/sec. (4.5 measurements/sec.)	
		12.00 cd/m <sup>2</sup> or higher 20 measurements/sec. (17 measurements/sec.)	
Display	Digital	xyLv, XYZ, TΔuvLv, u'v'Lv RGB analyze Chromaticity is displayed up to fourth decimal place. (Three-digit indication can be chosen.)	
	Analog	ΔxΔyΔLv, R/G B/G ΔG, ΔR B/R G/R	
	LCD	16 characters by 2 lines (with backlight)	
SYNC mode	NTSC, PAL, EXT, UNIV, INT		
Object under measurement	Vertical synchronizing frequency: 40 to 200 Hz		
Memory channel	100 channels		
Analyzer function	Standard function		
Interface	RS-232C (38,400 bps or below), USB (1.1 conformity)		
Multi-point Measurement	Max. 5 points(Use 4-Probe Expansion Board CA-B14)		
Software	SDK software (supplied as standard accessory)		
Operating temperature/humidity range	Temperature : 10 to 28°C ; relative humidity 70 % or less with no condensation Luminance change : ±2 % ±1 digit of reading for white Chromaticity change : ±0.002 for white, ±0.006 for monochrome from reading of Konica Minolta's standard LCD, 120 cd/m <sup>2</sup> *1		
Storage temperature /humidity range	0 to 28°C ; relative humidity 70 % or less with no condensation 28 to 40°C ; relative humidity 40 % or less with no condensation		
Input voltage range	100 – 240 V~, 50–60 Hz, 50 VA		
Size	Main body: 340 (W) × 127 (H) × 216 (D) mm, Probe: φ49 × 232 mm		
Weight	Main body: 3.58 kg, Probe: 540 g		
Standard accessories	AC power cord, PC Software for Color Analyzer CA-SDK, Small Hood CA-HS10		
Optional accessories	4-Probe Expansion Board CA-B14, Small Universal Measuring Probe CA-PSU12(2 m)CA-PSU15(5 m), Small Hood CA-HS10, Small Lens Cap CA-HS11		

\*1 : The luminance and chromaticity are measured under Konica Minolta's condition (standard LCD(6500 K, 9300 K) is used).

\*2 : The luminance for monochrome is measured when the reading of luminance for white is 120 cd/m<sup>2</sup>.

\*3 : Mesuring probe connected to probe connector P1 only, USB is used(RS-232C;38,400 bps baud rate is used).

• The specifications given in this manual are subject to change without prior notice.

Item		CA-210(LCD Flicker Measuring Probe)	
Receptor		Detector: Silicon photo cell	
Measurement area		φ27 mm	
Acceptance angle		±2.5°	
Pointing function		By LED	
Measurement distance		30±10 mm	
Display range	Luminance	0.01 to 1000 cd/m <sup>2</sup>	
	Chromaticity	Displayed in 4 or 3-digit value (Can be chosen)	
Luminance	Measurement range	0.10 to 1000 cd/m <sup>2</sup>	
	Accuracy(for white)*1	±2 %±1 digit of reading(temperature:23°C±2°C, relative humidity:(40±10) %)	
	Repeatability*1	0.10 to 0.99 cd/m <sup>2</sup> 1.00 to 1000 cd/m <sup>2</sup>	0.2%+1 digit (2 σ) 0.1%+1 digit (2 σ)
Chromaticity	Measurement range	0.10 to 1000 cd/m <sup>2</sup>	
	Accuracy*1	0.10 to 4.99 cd/m <sup>2</sup> 5.00 to 19.99 cd/m <sup>2</sup> 20.00 to 1000 cd/m <sup>2</sup> 120 cd/m <sup>2</sup>	±0.005 for white ±0.004 for white ±0.003 for white ±0.002 for white (±0.004 for monochrome)*2 (temperature:23°C±2°C, relative humidity:(40±10) %)
	Repeatability*1	0.10 to 0.19 cd/m <sup>2</sup>	0.010 (2 σ)
		0.20 to 0.49 cd/m <sup>2</sup>	0.005 (2 σ)
0.50 to 0.99 cd/m <sup>2</sup>		0.002 (2 σ)	
1.00 to 1000 cd/m <sup>2</sup>		0.001 (2 σ)	
Flicker Contrast method	Measurement range	5 cd/m <sup>2</sup> or higher	
	Display range	0.0 to 100%	
	Accuracy	±1% (Flicker frequency : 30 Hz AC/DC 10% sine wave)	
		±2% (Flicker frequency : 60 Hz AC/DC 10% sine wave)	
Repeatability	1% (2 σ) (Flicker frequency : 20 to 65Hz AC/DC 10% sine wave)		
Flicker JEITA method *1	Measurement range	5 cd/m <sup>2</sup> or higher	
	Accuracy	±0.5 dB (Flicker frequency : 30 Hz AC/DC 10% sine wave)	
	Repeatability	0.3dB (2 σ) (Flicker frequency : 30 Hz AC/DC 10% sine wave)	
Measurement speed *3	xyLv	0.10 to 1.99 cd/m <sup>2</sup>	5 measurements/sec. (4.5 measurements/sec.)
		2.00 cd/m <sup>2</sup> or higher	20 measurements/sec. (17 measurements/sec.)
	Flicker Contrast	16 measurements/sec. (16 measurements/sec.)	
Flicker JEITA	0.5 measurements/sec. (0.3 measurements/sec.) *4, *5		
Display	Digital	xyLv, XYZ, TΔuvLv, u'v'Lv RGB analyze Chromaticity is displayed up to fourth decimal place. (Three-digit indication can be chosen.) Flicker (Contrast method) *5	
	Analog	ΔxΔyΔLv, R/G B/G ΔG, ΔR B/R G/R, Flicker (Contrast method) *5	
	LCD	16 characters by 2 lines (with backlight)	
SYNC mode	NTSC, PAL, EXT, UNIV, INT		
Object under measurement	Vertical synchronizing frequency: 40 to 200 Hz for luminance or chromaticity, 40 to 130 Hz for Flicker		
Memory channel	100 channels		
Analyzer function	Standard function		
Interface	RS-232C (38,400 bps or below), USB (1.1 conformity)		
Multi-point Measurement	Max. 5 points(Use 4-Probe Expansion Board CA-B14)		
Software	SDK software (supplied as standard accessory)		
Operating temperature/humidity range	Temperature : 10 to 28°C ; relative humidity 70 % or less with no condensation Luminance change : ±2 % ±1 digit of reading for white Chromaticity change : ±0.002 for white, ±0.006 for monochrome from reading of Konica Minolta's standard LCD, 120 cd/m <sup>2</sup> *1		
Storage temperature /humidity range	0 to 28°C ; relative humidity 70 % or less with no condensation 28 to 40°C ; relative humidity 40 % or less with no condensation		
Input voltage range	100 – 240 V ~ , 50–60 Hz, 50 VA		
Size	Main body: 340 (W) × 127 (H) × 216 (D) mm, Probe: φ49 × 204 mm		
Weight	Main body: 3.58 kg, Probe: 520 g		
Standard accessories	AC power cord, PC Software for Color Analyzer CA-SDK, Standard Hood CA-H10		
Optional accessories	4-Probe Expansion Board CA-B14, LCD Flicker Measuring Probe CA-P12(2 m)CA-P15(5 m), Standard Hood CA-H10, Standard Lens Cap CA-H11		

\*1 : The luminance and chromaticity are measured under Konica Minolta's condition (standard LCD(6500 K, 9300 K) is used).

\*2 : The luminance for monochrome is measured when the reading of luminance for white is 120 cd/m<sup>2</sup>.

\*3 : Mesuring probe connected to probe connector P1 only, USB is used(RS-232C;38,400 bps baud rate is used).

\*4 : Measured by Konica Minolta's PC (P3-600 MHz)

\*5 : Measurement of flicker (JEITA method) is supported by SDK software.

• The specifications given in this manual are subject to change without prior notice.

Item		CA-210(Small LCD Flicker Measuring Probe)		
Receptor		Detector: Silicon photo cell		
Measurement area		φ10 mm		
Acceptance angle		±5°		
Pointing function		By LED		
Measurement distance		30±5 mm		
Display range	Luminance	0.01 to 3000 cd/m <sup>2</sup>		
	Chromaticity	Displayed in 4 or 3-digit value (Can be chosen)		
Luminance	Measurement range	0.30 to 3000 cd/m <sup>2</sup>		
	Accuracy(for white)*1	±2 %±1 digit of reading(temperature:23°C±2°C, relative humidity:(40±10) %)		
	Repeatability*1	0.30 to 2.99 cd/m <sup>2</sup>	0.2%+1 digit (2 σ)	
		3.00 to 3000 cd/m <sup>2</sup>	0.1%+1 digit (2 σ)	
Chromaticity	Measurement range	0.30 to 3000 cd/m <sup>2</sup>		
	Accuracy*1	0.30 to 14.99 cd/m <sup>2</sup>	±0.005 for white	(temperature:23°C±2°C, relative humidity:(40±10) %)
		15.00 to 59.99 cd/m <sup>2</sup>	±0.004 for white	
		60.00 to 3000 cd/m <sup>2</sup>	±0.003 for white	
		120 cd/m <sup>2</sup>	±0.002 for white	
Repeatability*1	0.30 to 0.59 cd/m <sup>2</sup>	0.010 (2 σ)		
		0.60 to 1.49 cd/m <sup>2</sup>	0.005 (2 σ)	
		1.50 to 2.99 cd/m <sup>2</sup>	0.002 (2 σ)	
		3.00 to 3000 cd/m <sup>2</sup>	0.001 (2 σ)	
Flicker Contrast method	Measurement range	15 cd/m <sup>2</sup> or higher		
	Display range	0.0 to 100%		
	Accuracy	±1% (Flicker frequency : 30 Hz AC/DC 10% sine wave)		
		±2% (Flicker frequency : 60 Hz AC/DC 10% sine wave)		
Repeatability	1% (2 σ) (Flicker frequency : 20 to 65Hz AC/DC 10% sine wave)			
Flicker JEITA method *1	Measurement range	15 cd/m <sup>2</sup> or higher		
	Accuracy	±0.5dB (Flicker frequency : 30 Hz AC/DC 10% sine wave)		
	Repeatability	0.3dB (2 σ) (Flicker frequency : 30 Hz AC/DC 10% sine wave)		
Measurement speed *3	xyLv	0.30 to 5.99 cd/m <sup>2</sup>	5 measurements/sec. (4.5 measurements/sec.)	
		6.00 cd/m <sup>2</sup> or higher	20 measurements/sec. (17 measurements/sec.)	
	Flicker Contrast	16 measurements/sec. (16 measurements/sec.)		
	Flicker JEITA	0.5 measurements/sec. (0.3 measurements/sec.) *4, *5		
Display	Digital	xyLv, XYZ, TΔuvLv, u'v'Lv RGB analyze Chromaticity is displayed up to fourth decimal place. (Three-digit indication can be chosen.) Flicker (Contrast method)*5		
	Analog	ΔxΔyΔLv, R/G B/G ΔG, ΔR B/R G/R, Flicker (Contrast method)*5		
	LCD	16 characters by 2 lines (with backlight)		
SYNC mode	NTSC, PAL, EXT, UNIV, INT			
Object under measurement	Vertical synchronizing frequency: 40 to 200 Hz for luminance or chromaticity, 40 to 130 Hz for Flicker			
Memory channel	100 channels			
Analyzer function	Standard function			
Interface	RS-232C (38,400 bps or below), USB (1.1 conformity)			
Multi-point Measurement	Max. 5 points(Use 4-Probe Expansion Board CA-B14)			
Software	SDK software (supplied as standard accessory)			
Operating temperature/humidity range	Temperature : 10 to 28°C ; relative humidity 70 % or less with no condensation Luminance change : ±2 % ±1 digit of reading for white Chromaticity change : ±0.002 for white, ±0.006 for monochrome from reading of Konica Minolta's standard LCD, 120 cd/m <sup>2</sup> *1			
Storage temperature /humidity range	0 to 28°C ; relative humidity 70 % or less with no condensation 28 to 40°C ; relative humidity 40 % or less with no condensation			
Input voltage range	100 – 240 V~, 50–60 Hz, 50 VA			
Size	Main body: 340 (W) × 127 (H) × 216 (D) mm, Probe: φ49 × 232 mm			
Weight	Main body: 3.58 kg, Probe: 540 g			
Standard accessories	AC power cord, PC Software for Color Analyzer CA-SDK, Small Hood CA-HS10			
Optional accessories	4-Probe Expansion Board CA-B14, Small LCD Flicker Measuring Probe CA-PS12(2 m)/CA-PS15(5 m) Small Hood CA-HS10, Small Lens Cap CA-HS11			

\*1 : The luminance and chromaticity are measured under Konica Minolta's condition (standard LCD(6500 K, 9300 K) is used).

\*2 : The luminance for monochrome is measured when the reading of luminance for white is 120 cd/m<sup>2</sup>.

\*3 : Mesuring probe connected to probe connector P1 only, USB is used(RS-232C;38,400 bps baud rate is used).

\*4 : Measured by Konica Minolta's PC (P3-600 MHz)

\*5 : Measurement of flicker (JEITA method) is supported by SDK software.

• The specifications given in this manual are subject to change without prior notice.

# Measurement/Quick Guide

Before starting measurement, perform necessary preparations as explained in the Installation/Connection section (page 23).

## <Zero Calibration> Page 34

1. Check that the POWER switch is set to ON.
2. Set the Pointing ring of the measuring probe to the 0-CAL position.

**When the optional 4-Probe Expansion Board CA-B14 is used**

Set the Pointing ring of every measuring probe to the 0-CAL position.

3. Press the **[0-CAL]** key.

The digital and analog display sections will light up and measurement starts.

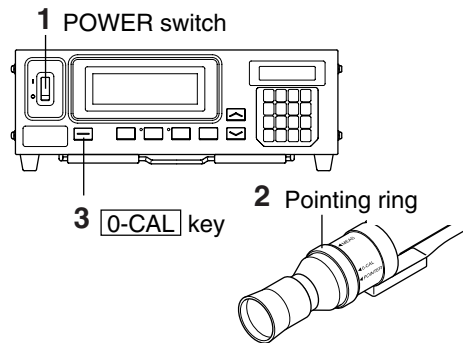

## <Selecting Measurement Speed> Page 36

Not required in case of flicker measurement\*\*.

1. Press the **[MENU]** key to display the menu selection screen.
2. Press the **[SPACE CAL]** key to open the measurement speed selection screen.

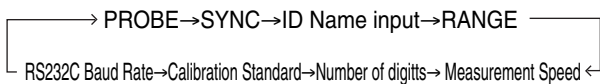

3. Press the **[Blue Right Arrow]** key to display the desired measurement speed.

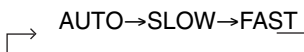

4. Press the **[ENTER]** key to confirm the selection.

Menu selection screen

MENU : SELECT  
PUSH SPACE KEY

Measurement speed selection screen

SELECT : M-SPD  
AUTO

SELECT : M-SPD  
SLOW

SELECT : M-SPD  
FAST

Press the **[Blue Right Arrow]** key until the desired measurement speed appears.

"F" is displayed when the [FAST] was selected.

CH00 EXT Fd P1  
[ ]

## <Selecting SYNC Mode> Page 36

1. Press the **[MENU]** key to display the menu selection screen.
2. Press the **[SPACE CAL]** key to open the SYNC selection screen.
3. Press the **[Blue Right Arrow]** key until the desired SYNC mode appears.



4. Press the **[ENTER]** key to confirm the selection.

\* To use EXT mode, the vertical synchronizing signal used for the display must be input to the instrument. (Page 28)

Menu selection screen

MENU : SELECT  
PUSH SPACE KEY

SYNC selection screen

SELECT : SYNC.  
EXT

SELECT : SYNC.  
UNIV

Press the **[Blue Right Arrow]** key until the desired SYNC mode appears.

## <Selecting Measurement Mode> Page 40

1. Press the **[MODE]** key until the desired measurement mode appears.

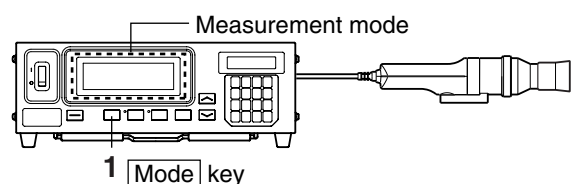
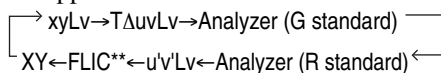

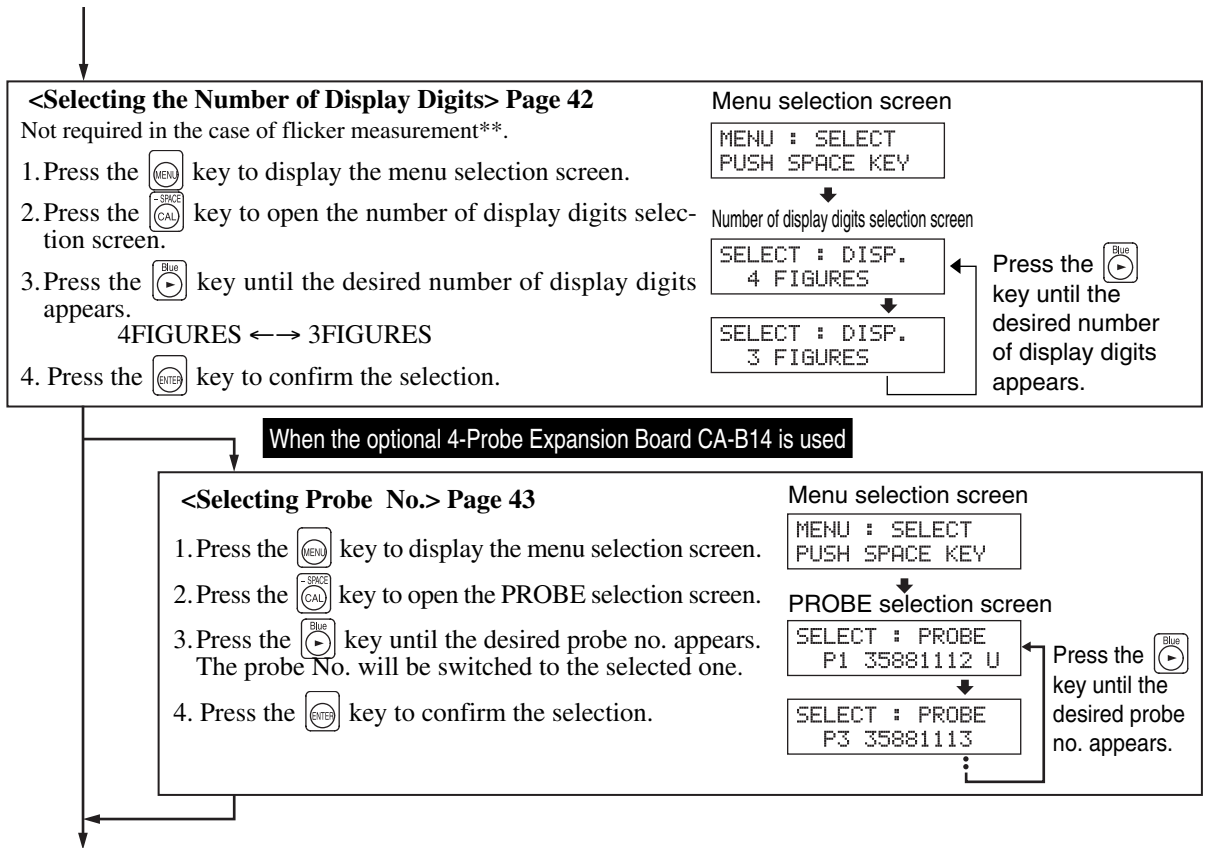

\*\*Flicker Mode is a function which can be used only when LCD Flicker Measuring Probe(CA-P12/15) or Small LCD Flicker Measuring Probe(CA-PS12/15) is connected.

**When the optional 4-Probe Expansion Board CA-B14 is used**

In Flicker Mode with LCD Flicker Measuring Probe(CA-P12/15) or Small LCD Flicker Measuring Probe(CA-PS12/15) connected, a selected probe cannot be changed to Universal Measuring Probe(CA-PU12/15) or Small Universal Measuring Probe(CA-PSU12/15).

From the Measurement Preparation section

When performing measurement using Konica Minolta calibration standard

**<Selecting the Calibration Standard> Page 50**  
 Not required in the case of flicker measurement\*\*.

1. Press the key to display the menu selection screen.
2. Press the key to open the calibration standard selection screen.
3. Press the key until the desired calibration standard appears.  
6500K ↔ 9300K
4. Press the key to confirm the selection.

\* The selected calibration standard will be set for CH00 as well as for all the memory channels that have not been user-calibrated.

**\*1 <Setting/Changing the Target Color> Page 62**  
 Not required in the case of flicker measurement\*\*.

**1. Setting/Changing the Target Color by Measurement Page 63**  
 This method can be used for any memory channels.

**When the optional 4-Probe Expansion Board CA-B14 is used**

- ① Press the key to display the menu selection screen.
- ② Press the key to open the PROBE selection screen.
- ③ Press the key until the desired probe no. appears.
- ④ Press the key to confirm the selection.

Memory channel	Probe no.
CH01	EXT Ad P1U
[	]

1. Press the CH and keys to select the desired memory channel.
2. Place the measuring probe against the display and take measurement.
3. Press the key.  
The HOLD LED will light up.
4. Press the key.
5. Press the key. Measurement will start.  
The HOLD LED will light off.

Not required in the case of flicker measurement\*\*.

**2. Setting/Changing the Target Color by Entering Values Page 65**  
 This method can be used for memory channel CH00 only.

**When the optional 4-Probe Expansion Board CA-B14 is used**

- ① Press the key to display the menu selection screen.
- ② Press the key to open the PROBE selection screen.
- ③ Press the key until the desired probe no. appears.
- ④ Press the key to confirm the selection.

Memory channel	Probe no.
CH00	EXT Ad P1U
[	]

1. Press the CH and keys to select CH00.
2. Press the key.

CH00	x	y	Lv	P1
	3127	3293	160.0	

Cursor

3. Enter the target color (x, y, Lv).

Ten-key (, , )... Used to enter values.  
 Key ..... The cursor moves in the order  
 x → y → Lv → x.

4. Press the key.

● To set an ID name : \*2 <Setting an ID Name> Page 118  
 ● To use the analog display function : \*3 <Setting the Analog Display Range> Page 118

To the Measurement section Page 75

From the Measurement Preparation section

↓ When performing measurement using user calibration

**<User Calibration> Page 51**

Not required in the case of flicker measurement\*\*.

**1. Performing White Calibration Page 52**

Cannot be performed with memory channel CH00.

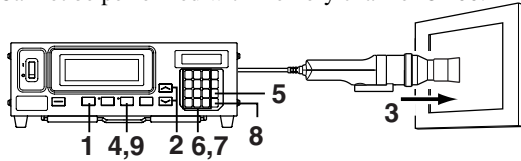

When the optional 4-Probe Expansion Board CA-B14 is used

User calibration is performed independently for probe no. ([P1] to [P5]) for each memory channel.

- ① Press the key to display the menu selection screen.
- ② Press the key to open the PROBE selection screen.
- ③ Press the key until the desired probe no. appears.
- ④ Press the key to confirm the selection.

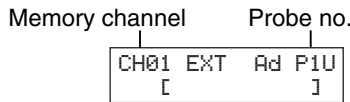

1. Press the key to select xyLv mode.
2. Press the CH and keys to select the desired memory channel.
3. Place the measuring probe against the display which is displaying the known white color.
4. Press the key.  
The HOLD LED will light up.
5. Press the key. 

CH01	U-CAL
P1	W R G B
6. Press the key. 

CH01	x	y	Lv	P1
0000	0000	0.00		
7. Enter the calibration values (x, y, Lv).  
Ten-key ( to )... Used to enter values.  
Key ... The cursor moves in the order x → y → Lv → x.  

CH01	x	y	Lv	P1
3300	3000	39.50		

  
Cursor
8. Press the key. 

CH01	U-CAL
P1	*W R G B

  
" \* " mark is displayed.  
(The mark will be displayed for W when the value is entered.)
9. Press the key. 

CH01	EXT	Ad	P1U
[			]
10. Press the key. Measurement will start.  
The HOLD LED will light off.

- To change the target color after user calibration:  
\*1 <Setting/Changing the Target Color> Page 116
- To set an ID name:  
\*2 <Setting an ID Name> Page 118
- To use the analog display function:  
\*3 <Setting the Analog Display Range> Page 118

Not required in the case of flicker measurement\*\*.

**2. Performing Matrix Calibration Page 54**

Cannot be performed with memory channel CH00.

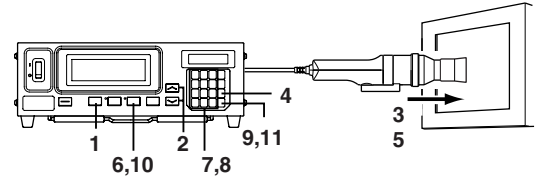

When the optional 4-Probe Expansion Board CA-B14 is used

User calibration is performed independently for probe no. ([P1] to [P5]) for each memory channel.

- ① Press the key to display the menu selection screen.
- ② Press the key to open the PROBE selection screen.
- ③ Press the key until the desired probe no. appears.
- ④ Press the key to confirm the selection.

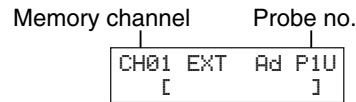

1. Press the key to select xyLv mode.
2. Press the CH and keys to select the desired memory channel.
3. Place the measuring probe against the display and set the display so that it can display known RGBW.
4. Press the key. 

CH01	U-CAL
P1	W R G B
5. Cause the display to show red (green), (blue), (white).
6. Press the key.  
The HOLD LED will light up.
7. Press the () () () key. 

CH01	x	y	Lv	P1
0000	0000	0.00		
8. Enter the calibration values (x, y, Lv) for R.  
Ten-key ( to )... Used to enter values.  
Key ... The cursor moves in the order x → y → Lv → x.  

CH01	x	y	Lv	P1
3300	3000	39.50		

  
Cursor
9. Press the key. 

CH01	U-CAL
P1	W *R G B

  
" \* " mark is displayed.  
(The same mark will be displayed for G, B and W when their values are entered.)
10. Press the key. 

CH01	x	y	Lv	P1
3300	3000	39.50		

  
Cursor  
The HOLD LED will light off. Measurement will start.  
\* Repeat steps 4 to 10 for G, B and W.
11. Press the key. 

CH01	EXT	Am	P1U
[			]

  
Matrix calibration will be performed.

To the Measurement section Page 75

↓ When performing measurement in analyzer mode

**<Inputting the RGB Emission Characteristic for Analyzer mode> Page 59**  
Can be set to all the memory channels.

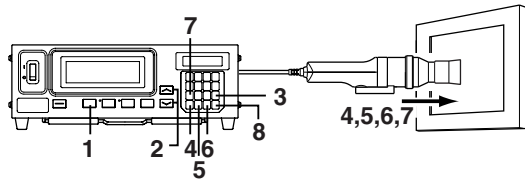

**When the optional 4-Probe Expansion Board CA-B14 is used**

User calibration is performed independently for probe connectors ([P1] to [P5]) for each memory channel.

- ① Press the **[MENU]** key to display the menu selection screen.
- ② Press the **[SPACE CAL]** key to open the PROBE selection screen.
- ③ Press the **[Blue]** key until the desired probe no. appears.
- ④ Press the **[ENTER]** key to confirm the selection.

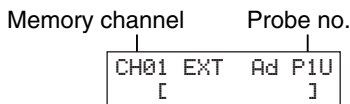

1. Press the **[MODE]** key to select analyzer mode.
2. Press the **CH** and keys to select the desired memory channel.
3. Press the **[SPACE CAL]** key.
4. Input the emission characteristic of R.
  - ① Place the measuring probe against the display, which is now emitting monochrome light of R. 

CH01	ALZ
P1 W *R G B	
  - ② Press the **[Red 0]** key. 

CH01	ALZ
P1 W *R *G B	

  
In the LCD display section, the "\*" mark will appear on the left of "R".
5. Input the emission characteristic of G.
  - ① Place the measuring probe against the display, which is now emitting monochrome light of G. 

CH01	ALZ
P1 W *R *G B	
  - ② Press the **[Green 0]** key. 

CH01	ALZ
P1 W *R *G *B	

  
In the LCD display section, the "\*" mark will appear on the left of "G".
6. Input the emission characteristic of B.
  - ① Place the measuring probe against the display, which is now emitting monochrome light of B. 

CH01	ALZ
P1 W *R *G *B	
  - ② Press the **[Blue 0]** key. 

CH01	ALZ
P1 W *R *G *B	

  
In the LCD display section, the "\*" mark will appear on the left of "B".
7. Input the emission characteristic of W.
  - ① Place the measuring probe against the display, which is now emitting monochrome light of W. 

CH01	ALZ
P1 *W *R *G *B	
  - ② Press the **[White 1]** key. 

CH01	ALZ
P1 *W *R *G *B	

  
In the LCD display section, the "\*" mark will appear on the left of "W".
8. Press the **[ENTER]** key. 

CH01 EXT Ad P1U	
[ ]	

The RGB emission characteristic for the display and target color will be set.

- To change the target color after user calibration:  
\*1 <Setting/Changing the Target Color> Page 116
- To set an ID name:  
\*2 <Setting an ID Name> Page 118
- To use the analog display function:  
\*3 <Setting the Analog Display Range> Page 118

**\*2 <Setting an ID Name> Page 67**

Can be set to all the memory channels.

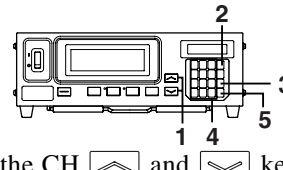

1. Press the **CH** and keys to select the desired memory channel. 

Memory channel
CH01 EXT Ad P1U
[ ]
2. Press the **[MENU]** key. 

MENU : SELECT
PUSH SPACE KEY
3. Press the **[SPACE CAL]** key to open the ID name input screen. 

Cursor ID name
CH01 EXT Ad P1
[EXT D-1.50]
4. Enter the desired ID name.  
Number-key (**[Red 0]** to **[Green 9]**, **[Green .]**) Used to enter values.  
**[LOCK ALPHA]** Key .. Can be used to enter an alphabet, hyphen (-) and space. Pressing this key again will restore the original function of the number-key.  
**[Blue >]** Key .. Moves the cursor to the right each time this key is pressed. 

Cursor ID name
CH01 EXT Ad P1
[EXT D-1.50]
5. Press the **[ENTER]** key. 

Cursor ID name
CH01 EXT Ad P1
[EXT D-1.50]

**\*3 <Setting the Analog Display Range> Page 69**

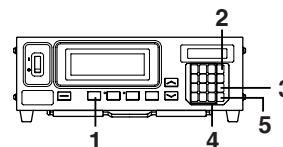

1. Press the **[MODE]** key to select the measurement mode for which you want to set the range.
2. Press the **[MENU]** key. 

MENU : SELECT
PUSH SPACE KEY
3. Press the **[SPACE CAL]** key to open the RANGE setting screen. 

RANGE x,y LV
(%) 10 10
4. Enter the desired range value.  
Ten-key (**[Red 0]** to **[Green 9]**, **[Green .]**)... Used to enter values.  
**[Blue >]** Key .. Moves the cursor to the right each time this key is pressed.
5. Press the **[ENTER]** key. 

For analyzer mode (G reference)
RANGE G B/G,R/G
(%) 10 10
For analyzer mode (R reference)
RANGE R B/G,R/G
(%) 10 10
For flicker mode**
RANGE FMA
(%) 10





KONICA MINOLTA